

DB-BT Sixth Floor

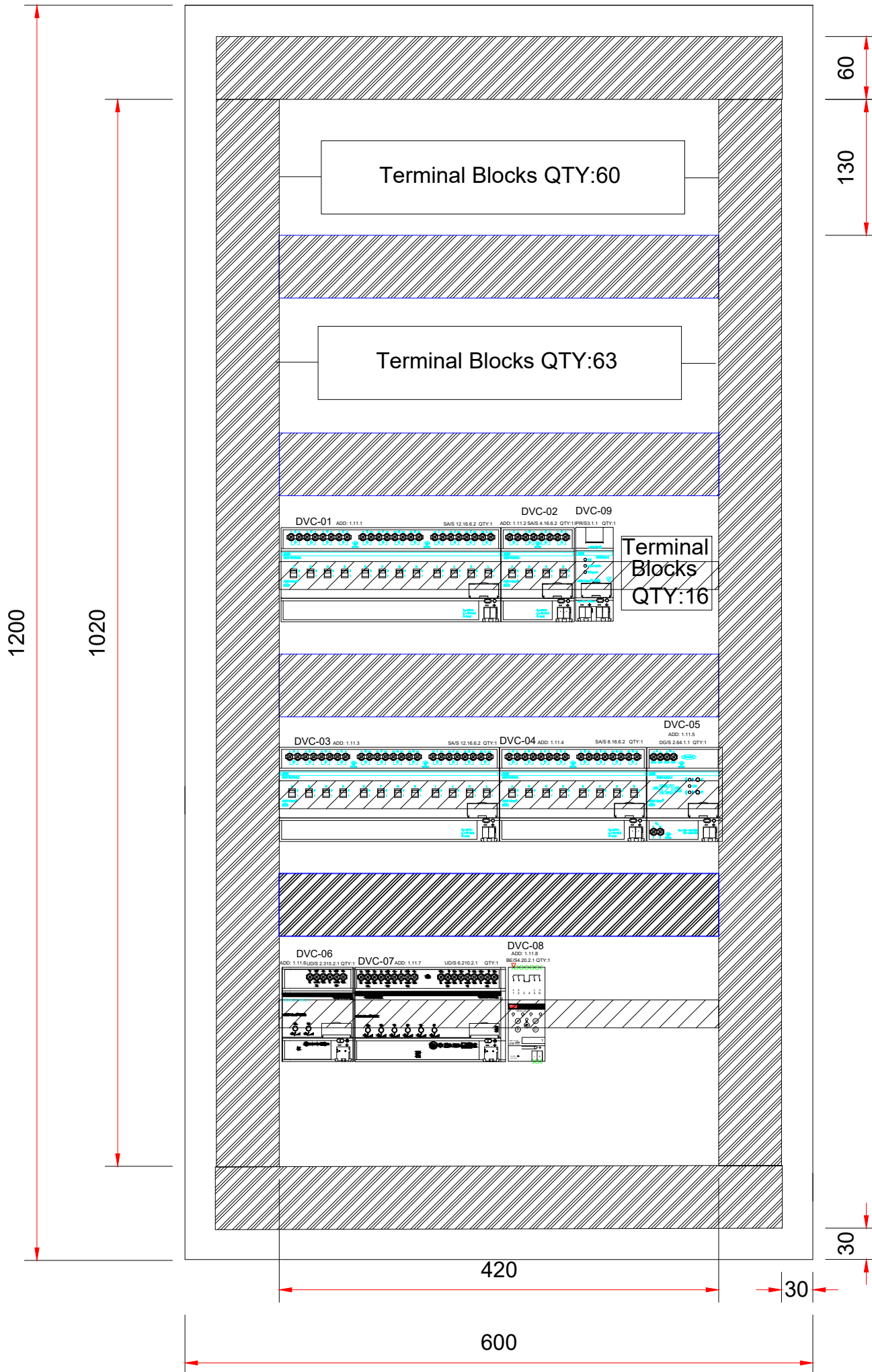

GENERAL NOTES:

System Integrator



OWNER:



CONSULTANT :



CONTRACTOR:



PROJECT TITLE:

HSBC Maadi Nile Cournich

DRAWING TITLE :

KNX PANEL SHOP DRAWINGS

DRAWING NUMBER :

DB-BT

PAGE: 1/12

PREPARED BY:	CHECKED BY:	APPROVED BY:
ENG. M.T	ENG.M.T	ENG.M.H
DATE	REV.	PROJECT NO.
Oct-2023	02	--
		PAPER
		A3

DVC-01

SAS 12.16.6.2/1 QTY:1 ADD: 1.11.1

GENERAL NOTES:

3 R1 4 R1 5 R1 6 Y1 7 Y1 8 Y1 9 Y1 10 Y1 11 Y1 12 Y1 13 Y1 18 B1

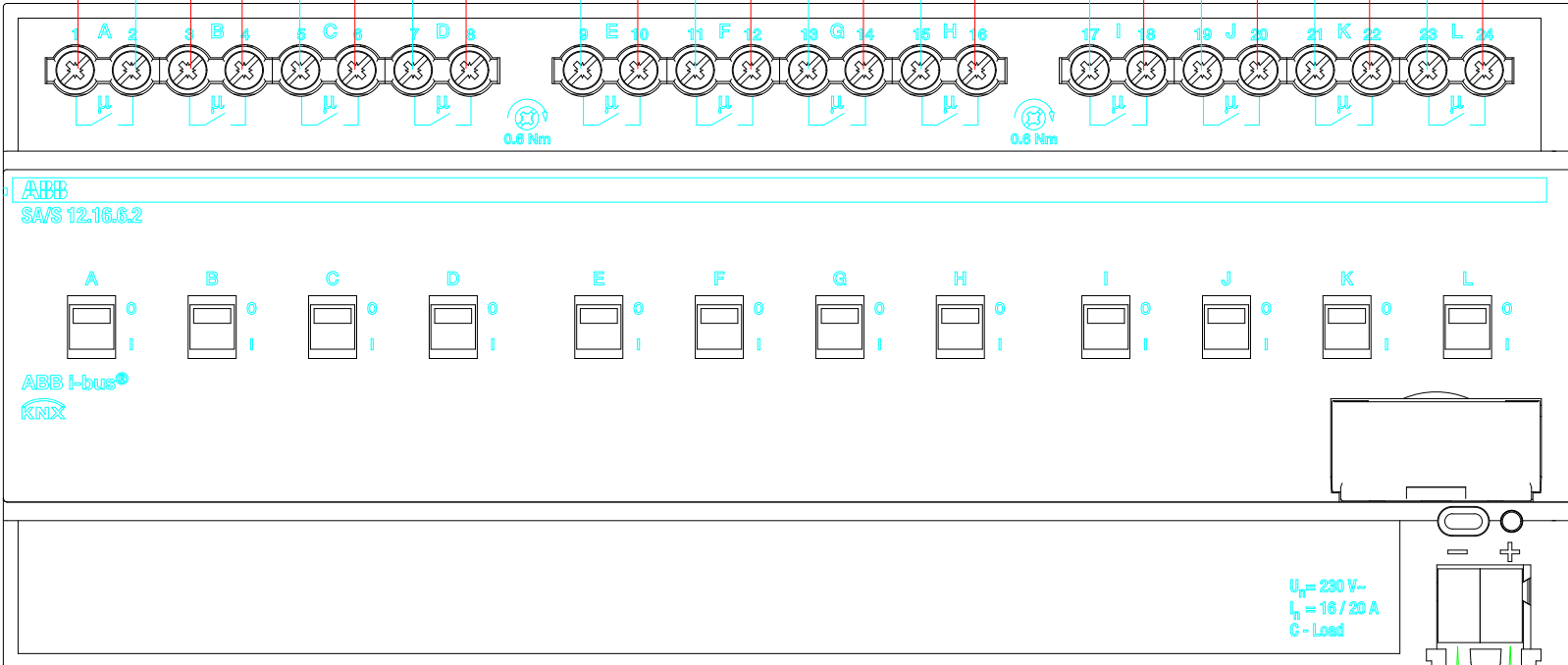

System Integrator



OWNER:



CONSULTANT:



CONTRACTOR:



PROJECT TITLE:

HSBC Maadi Nile Courch

DRAWING TITLE :

KNX PANEL SHOP DRAWINGS

DRAWING NUMBER :

DB-BT

PAGE: 2/12

PREPARED BY:	CHECKED BY:	APPROVED BY:
ENG. M.T	ENG. M.T	ENG. M.H
DATE	REV.	PROJECT NO.
Oct-2023	02	--
		PAPER
		A4

KNX+ KNX+
 KNX- KNX-

DVC-02

SA/S 4.16.6.2 QTY:1

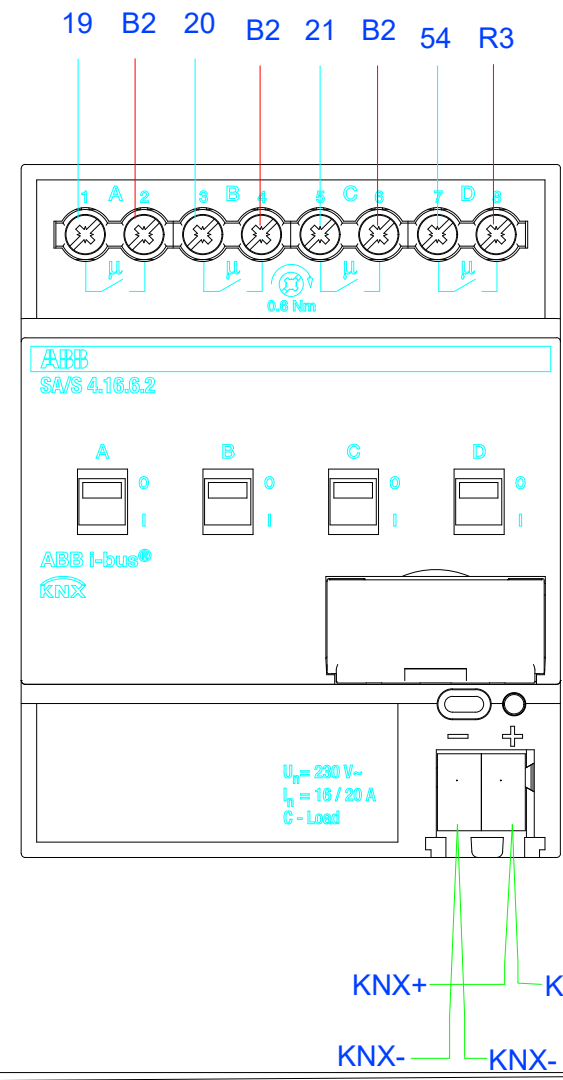

GENERAL NOTES:

System Integrator



OWNER:



CONSULTANT:



CONTRACTOR:



PROJECT TITLE:

HSBC Maadi Nile Courmich

DRAWING TITLE :

KNX PANEL SHOP DRAWINGS

DRAWING NUMBER :

DB-BT

PAGE: 3/12

PREPARED BY:		CHECKED BY:		APPROVED BY:	
DATE	REV.	PROJECT NO.	PAPER	ENG. M.T	ENG. M.H
Oct-2023	02	--	A4		

DVC-03

SA/S 12.16.6.2/2 QTY:1

ADD: 1.11.3

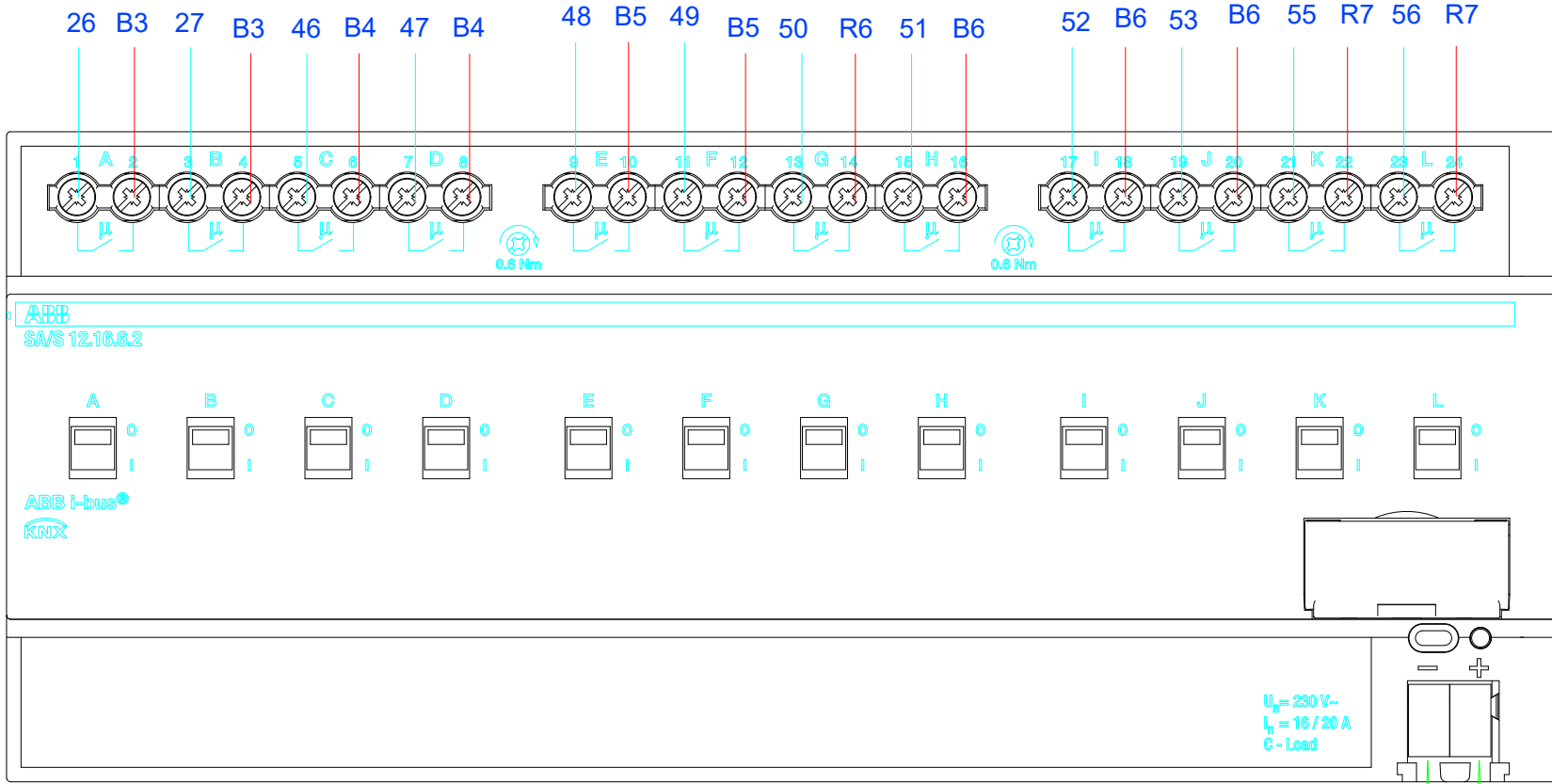

GENERAL NOTES:

System Integrator

OWNER:

CONSULTANT:

CONTRACTOR:

PROJECT TITLE:
HSBC Maadi Nile Courch

DRAWING TITLE :
KNX PANEL SHOP DRAWINGS

DRAWING NUMBER :
DB-BT
PAGE: 4/12

DATE	REV.	PROJECT NO.	PAPER
Oct-2023	02	--	A4

PREPARED BY: _____ CHECKED BY: _____ APPROVED BY: _____
ENG. M.T. ENG. M.T. ENG. M.H.

ADD: 1.11.4

DVC-04

SA/S 8.16.6.2 QTY:1

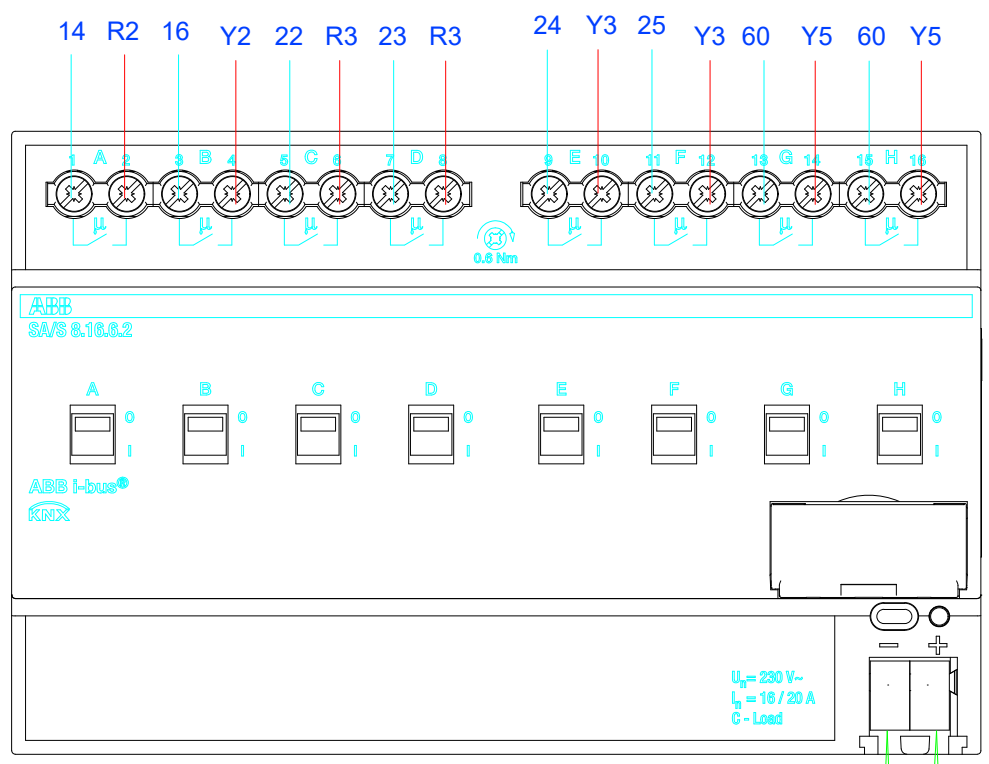

$U_n = 230\text{ V-}$
 $I_n = 16 / 20\text{ A}$
C - Load

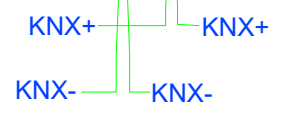

GENERAL NOTES:

System Integrator



OWNER:



CONSULTANT:



CONTRACTOR:



PROJECT TITLE:

HSBC Maadi Nile Courmich

DRAWING TITLE :

KNX PANEL SHOP DRAWINGS

DRAWING NUMBER :

DB-BT

PAGE: 5/12

PREPARED BY:	CHECKED BY:	APPROVED BY:	
ENG. M.T	ENG. M.T	ENG. M.H	
DATE	REV.	PROJECT NO.	PAPER
Oct-2023	02	-	A4

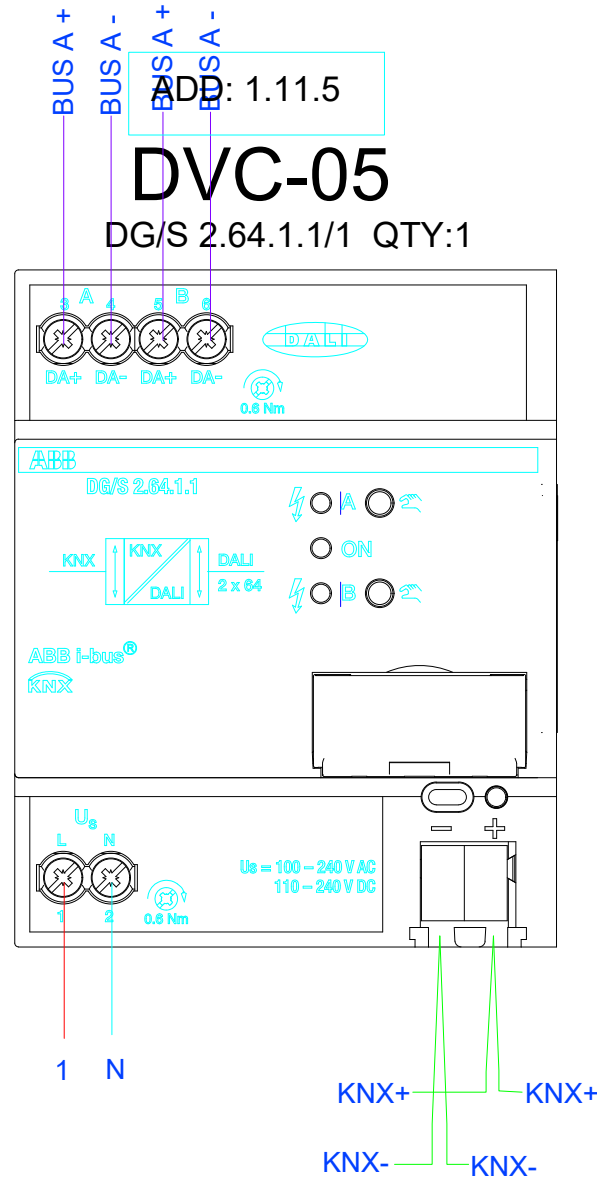

GENERAL NOTES:

System Integrator



OWNER:



CONSULTANT:



CONTRACTOR:



PROJECT TITLE:
HSBC Maadi Nile Courmich

DRAWING TITLE :
KNX PANEL SHOP DRAWINGS

DRAWING NUMBER :
DB-BT

PAGE: 6/12

PREPARED BY:		CHECKED BY:		APPROVED BY:	
ENG. M.T	ENG. M.T	ENG. M.T	ENG. M.H	ENG. M.H	ENG. M.H
DATE	REV.	PROJECT NO.	PAPER		
Oct-2023	02	--	A4		

ADD: 1.11.6

DVC-06

UD/S 2.315.2.1 QTY:1

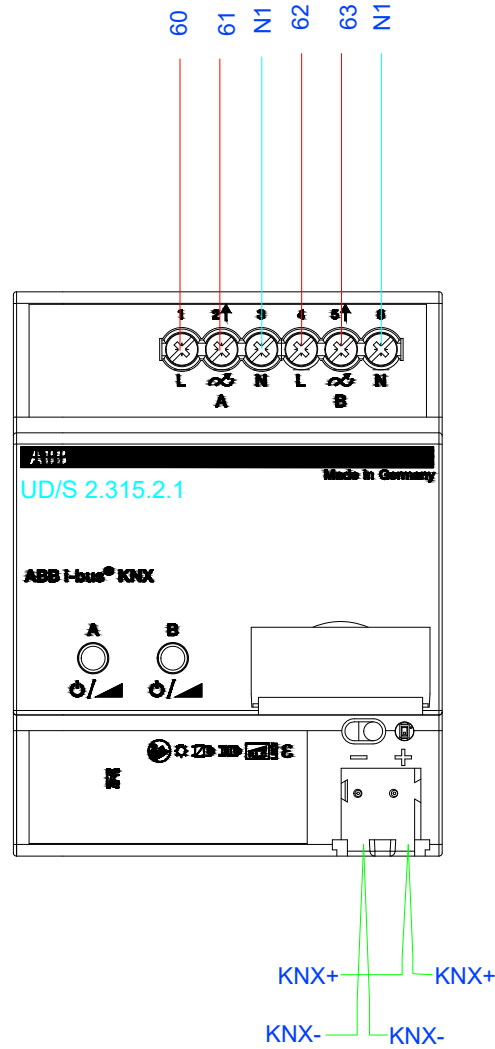

GENERAL NOTES:

System Integrator



OWNER:



CONSULTANT:



CONTRACTOR:



PROJECT TITLE:

HSBC Maadi Nile Courmich

DRAWING TITLE :

KNX PANEL SHOP DRAWINGS

DRAWING NUMBER :

DB-BT

PAGE: 7/12

PREPARED BY:	CHECKED BY:	APPROVED BY:	
ENG. M.T	ENG. M.T	ENG. M.H	
DATE	REV.	PROJECT NO.	PAPER
Oct-2023	02	--	A4

ADD: 1.11.7

DVC-07

UD/S 6.210.2.1/1 QTY:1

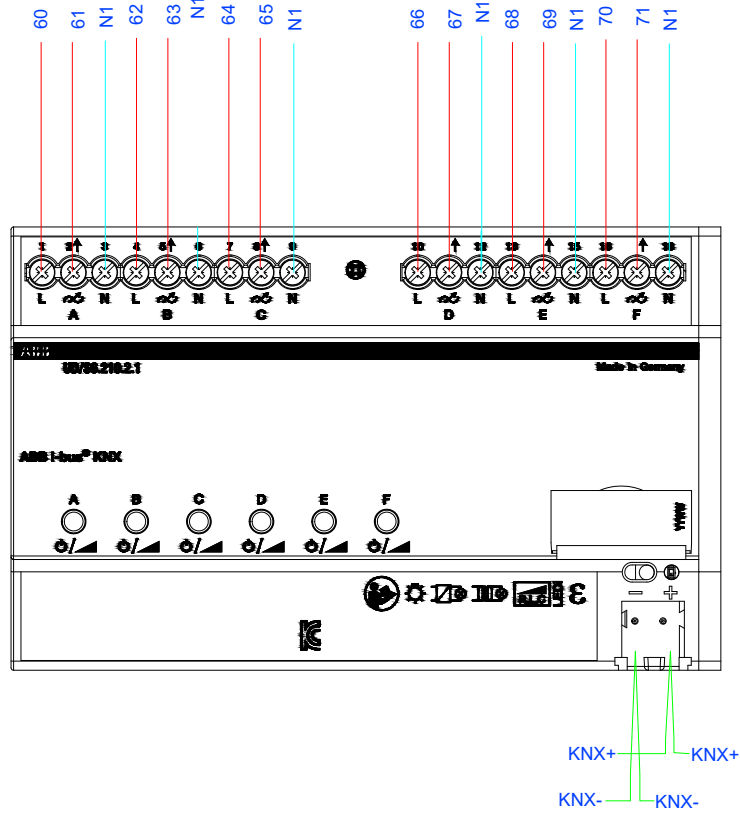

GENERAL NOTES:

System Integrator



OWNER:



CONSULTANT:



CONTRACTOR:



PROJECT TITLE:

HSBC Maadi Nile Courmich

DRAWING TITLE :

KNX PANEL SHOP DRAWINGS

DRAWING NUMBER :

DB-BT

PAGE: 8/12

PREPARED BY:	CHECKED BY:	APPROVED BY:	
ENG. M.T	ENG. M.T	ENG. M.H	
DATE	REV.	PROJECT NO.	PAPER
Oct-2023	02	--	A4

ADD: 1&11.8

DVC-08

BE/S4.20.2.1 QTY:1

N

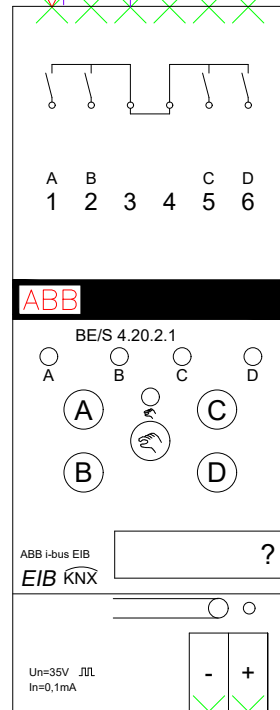

KNX+

KNX-

GENERAL NOTES:

System Integrator



OWNER:



CONSULTANT:



CONTRACTOR:



PROJECT TITLE:

HSBC Maadi Nile Courmich

DRAWING TITLE :

KNX PANEL SHOP DRAWINGS

DRAWING NUMBER :

DB-BT

PAGE: 9/12

PREPARED BY:	CHECKED BY:	APPROVED BY:	
ENG. M.T	ENG. M.T	ENG. M.H	
DATE	REV.	PROJECT NO.	PAPER
Oct-2023	02	--	A4

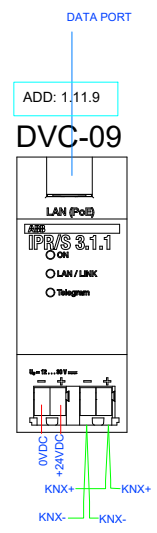

GENERAL NOTES:

System Integrator



OWNER:



CONSULTANT :



CONTRACTOR:



PROJECT TITLE:

HSBC Maadi Nile Courmich

DRAWING TITLE :

KNX PANEL SHOP DRAWINGS

DRAWING NUMBER :

DB-BT

PAGE: 10/12

PREPARED BY:	CHECKED BY:	APPROVED BY:	
ENG. M.T	ENG. M.T	ENG. M.H	
DATE	REV.	PROJECT NO.	PAPER
Oct-2023	02	--	A4

HSBC 6th floor

		NUMBER OF RETURNS CONTROLLED BY PRESENCE SENSOR ONLY / PIR & LIGHTING SWITCH / LIGHTING SWITCH ONLY	CIRCUIT COLOR	CIRCUIT NO.	RETURNS NO. FOR EACH CIRCUIT	LOCATION	NUMBER OF DALI LIGHTING FIXTURES (DALI DRIVER)	Actuator Address	Actuator Channel	PRESENCE SENSOR	KEYPAD & TOUCH SCREEN
6TH FLOOR	DB-BT	52	R1	CT1	1	CANCELLED (TB ONLY)	1	DVC-05 1.11.5	A B C	46	One TOUCH SCREEN IN ELEC ROOM G-143 and 7 keypads
					2	DALI Parent A L06-637					
					3	DOCTOR L06-636					
					4	room between doctor room & storage					
					5	FURNITURE STORAGE L06-638					
			Y1	CT2	6	IT CAGE L06-634	DVC-01 1.11.1	D			
					7	SHOWER L06-626					
					8	DISABLED TOILET L06-627					
					9	JANITOR L06-628					
					10	TOILET LOBBY					
					11	Female Toilet L06-629					
					12	IT EXPRESS CENTER L06-633					
			B1	CT3	13	IT EXPRESS CENTER L06-633	DVC-02 1.11.2	A B C			
			Y2	CT5	18	AUDIO VISUAL CONTROL ROOM L06-644					
			B2	CT6	19	CIRCULATION L06-647	DVC-03 1.11.3	A B C			
					20	FRONT PANEL EDB-BT					
			R3	CT7	21	CIRCULATION L06-647	DVC-04 1.11.4	D			
					54	50P TOWNHALL L06-646					
			B3	CT9	26	CIRCULATION L06-647	DVC-05 1.11.5	A B C			
					27	CIRCULATION L06-647					
			B4	CT12	46	CIRCULATION L06-647	DVC-06 1.11.6	D			
					47	CIRCULATION L06-647					
			B5	CT15	48	CIRCULATION L06-647	DVC-07 1.11.7	E F			
					49	CIRCULATION L06-647					
			R6	CT16	50	SPARE	DVC-08 1.11.8	G			
			B6	CT18	51	CIRCULATION L06-647					
					52	CIRCULATION L06-647					
					53	CIRCULATION L06-647					
			R7	CT19	55	SPARE	DVC-09 1.11.9	H I			
					56	SPARE					
			R2	CT4	14	50P TOWNHALL L06-646	DVC-10 1.11.10	A			
			Y2	CT5	16	CIRCULATION L06-647					
			R3	CT7	22	FURNITURE STORAGE L06-648	DVC-11 1.11.11	B			
23	50P TOWNHALL L06-646										
Y3	CT8	24	50P TOWNHALL L06-645	DVC-12 1.11.12	C						
		25	50P TOWNHALL L06-645								
Y5	CT14	58	SPARE	DVC-13 1.11.13	D						
		59	SPARE								
R4	CT10	28,29,30,31	6P MEETING ROOM L06-643	DVC-14 1.11.14	E						
		32,33	12P MEETING ROOM L06-642								
Y4	CT11	34,35,36,37	4P MEETING ROOM L06-641	DVC-15 1.11.15	A, B						
		38,39,40,41	6P MEETING ROOM L06-640								
		42,43,44,45	6P MEETING ROOM L06-639								

GENERAL NOTES:

System Integrator



OWNER:



CONSULTANT:



CONTRACTOR:



PROJECT TITLE:

HSBC Maadi Nile Courch

DRAWING TITLE :

KNX PANEL SHOP DRAWINGS

DRAWING NUMBER :

DB-BT

PAGE: 12/12

PREPARED BY:	CHECKED BY:	APPROVED BY:
ENG. M.T	ENG. M.T	ENG. M.H
DATE	REV.	PROJECT NO.
Oct-2023	02	--
		PAPER
		A4

EDB-BT Sixth Floor

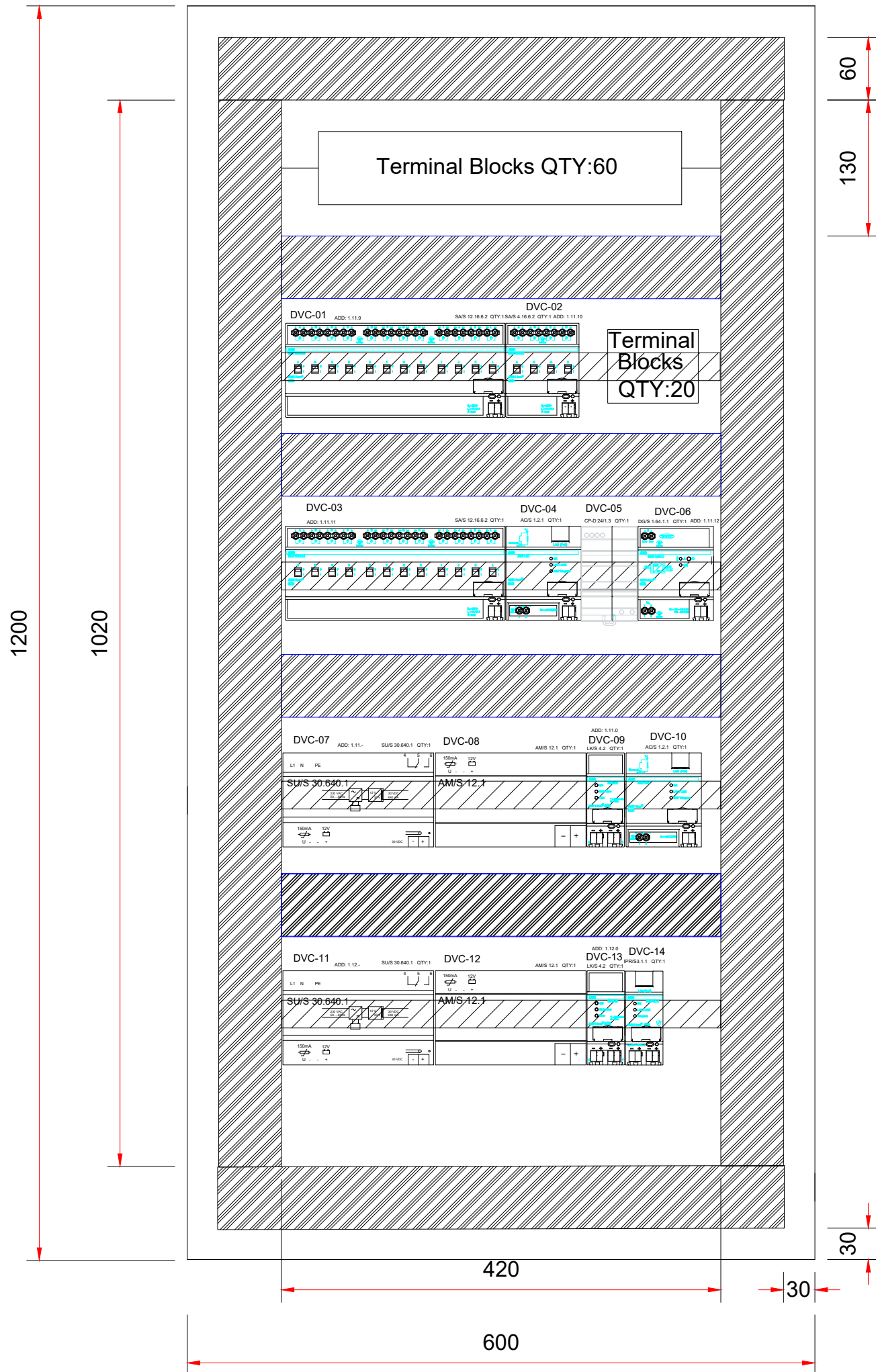

GENERAL NOTES:

System Integrator



OWNER:



CONSULTANT :



CONTRACTOR:



PROJECT TITLE:

HSBC Maadi Nile Cournich

DRAWING TITLE :

KNX PANEL SHOP DRAWINGS

DRAWING NUMBER :

EDB-BT

PAGE: 1/13

PREPARED BY:	CHECKED BY:	APPROVED BY:	
ENG. M.T	ENG.M.T	ENG.M.H	
DATE	REV.	PROJECT NO.	PAPER
Oct-2023	02	--	A3

DVC-01

SA/S 12.16.6.2/1 QTY:1

ADD: 1.13.1

GENERAL NOTES:

1 R1 2 Y1 3 Y1 4 Y1 5 B1 6 B1 7 B1 8 B1 9 B1 10 R2 11 Y2 12 Y2



ABB
 SA/S 12.16.6.2



ABB i-bus®
 KNX

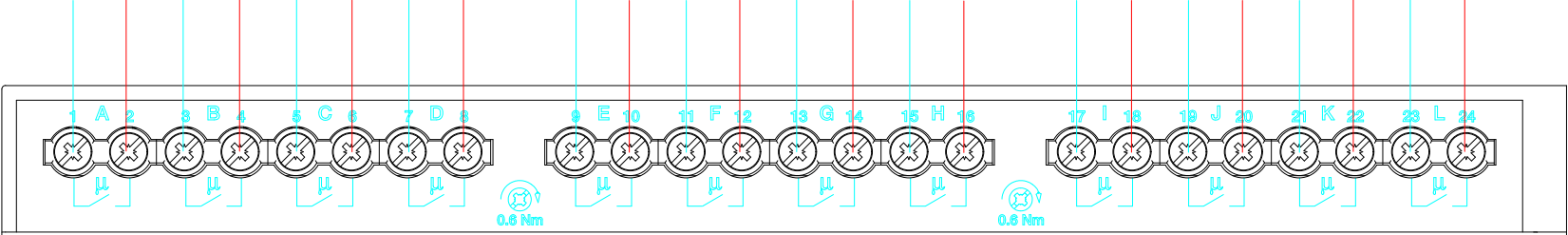

$U_n = 230\text{ V-}$
 $I_n = 16 / 20\text{ A}$
 C - Load

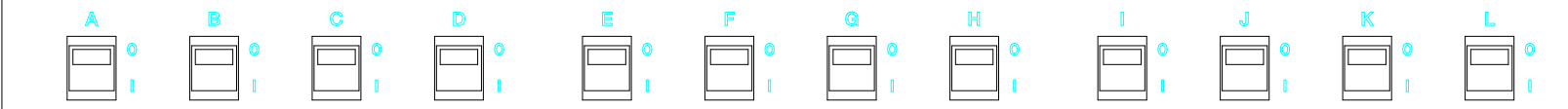
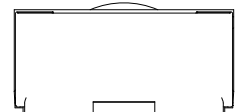
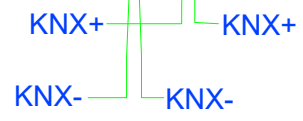

System Integrator



OWNER:



CONSULTANT:



CONTRACTOR:



PROJECT TITLE:

HSBC Maadi Nile Cournich

DRAWING TITLE :

KNX PANEL SHOP DRAWINGS

DRAWING NUMBER :

EDB-BT

PAGE: 2/13

DATE	REV.	PROJECT NO.	PAPER
Oct-2023	02	-	A4

DVC-03

SA/S 12.16.6.2/2 QTY:1

ADD: 1.13.3

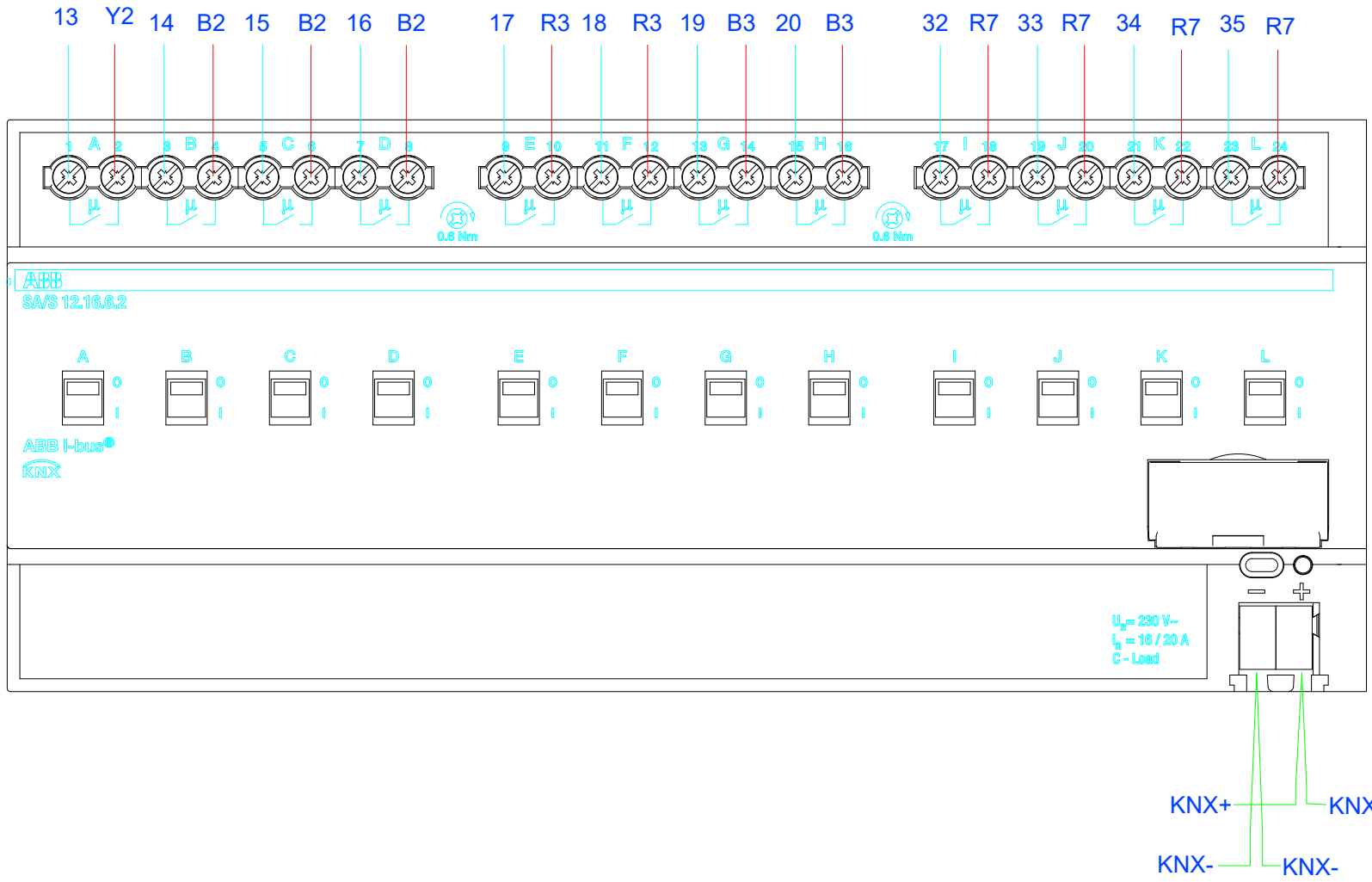

GENERAL NOTES:

System Integrator

OWNER:

CONSULTANT:

CONTRACTOR:

PROJECT TITLE:
HSBC Maadi Nile Courch

DRAWING TITLE :
KNX PANEL SHOP DRAWINGS

DRAWING NUMBER :
EDB-BT
PAGE: 3/13

DATE	REV.	PROJECT NO.	PAPER
Oct-2023	02	-	A4

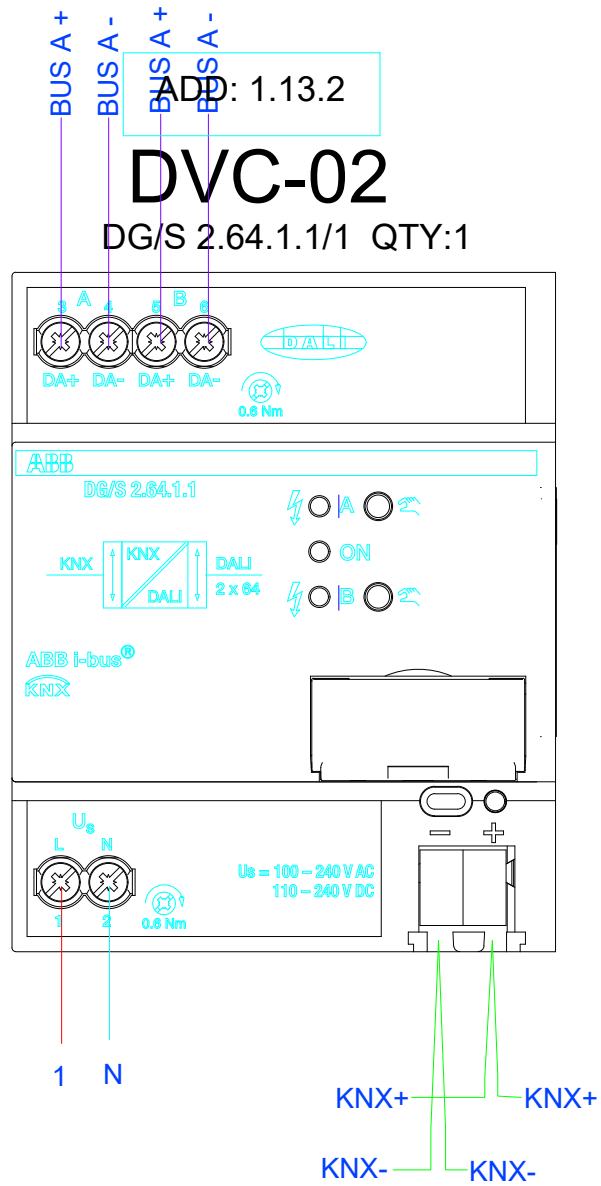

GENERAL NOTES:



PROJECT TITLE:
HSBC Maadi Nile Courmich

DRAWING TITLE :
KNX PANEL SHOP DRAWINGS

DRAWING NUMBER :
EDB-BT
PAGE: 4/13

PREPARED BY:		CHECKED BY:		APPROVED BY:	
ENG. M.T	ENG. M.T	ENG. M.T	ENG. M.H	ENG. M.H	ENG. M.H
DATE	REV.	PROJECT NO.	PAPER		
Oct-2023	02	--	A4		

ADD: 1.13.4

UD/S 4.210.2.1 QTY:1

DVC-04

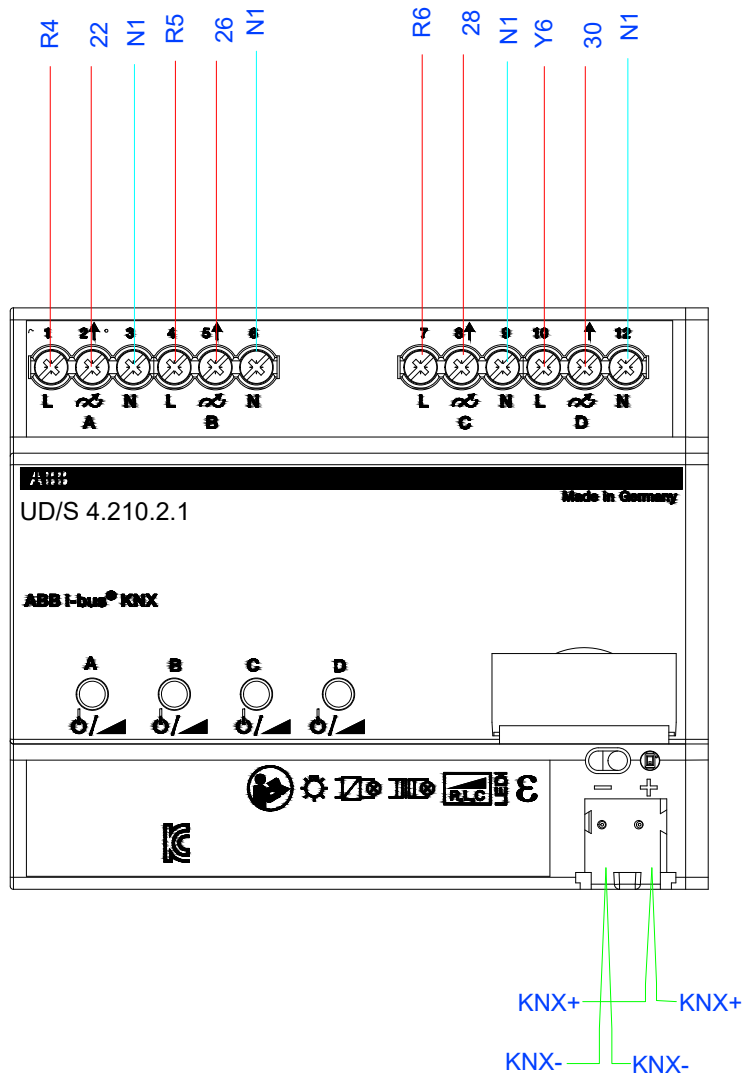

GENERAL NOTES:

System Integrator



OWNER:



CONSULTANT:



CONTRACTOR:



PROJECT TITLE:

HSBC Maadi Nile Courmich

DRAWING TITLE :

KNX PANEL SHOP DRAWINGS

DRAWING NUMBER :

EDB-BT

PAGE: 5/13

PREPARED BY: CHECKED BY: APPROVED BY:

ENG. M.T. ENG. M.T. ENG. M.H.

DATE REV. PROJECT NO. PAPER

Oct-2023 02 -- A4

2
QTY:1

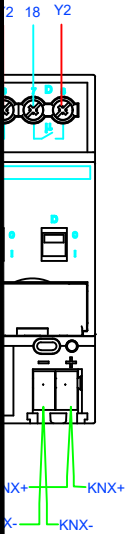

DATA PORT
DVC-04
AC/S 1.2.1 QTY:1

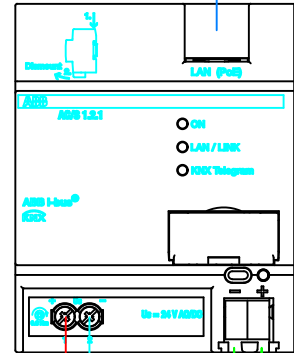

DVC-05
CP-D 24/1.3 QTY:1

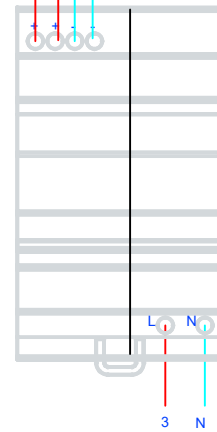

6TH FLOOR

GENERAL NOTES:

System Integrator



OWNER:



CONSULTANT:



CONTRACTOR:



PROJECT TITLE:

HSBC Maadi Nile Courmich

DRAWING TITLE :

KNX PANEL SHOP DRAWINGS

DRAWING NUMBER :

EDB-BT

PAGE: 6/13

DATE	REV.	PROJECT NO.	PAPER
Oct-2023	02	--	A4

PREPARED BY:	CHECKED BY:	APPROVED BY:
ENG. M.T	ENG. M.T	ENG. M.H

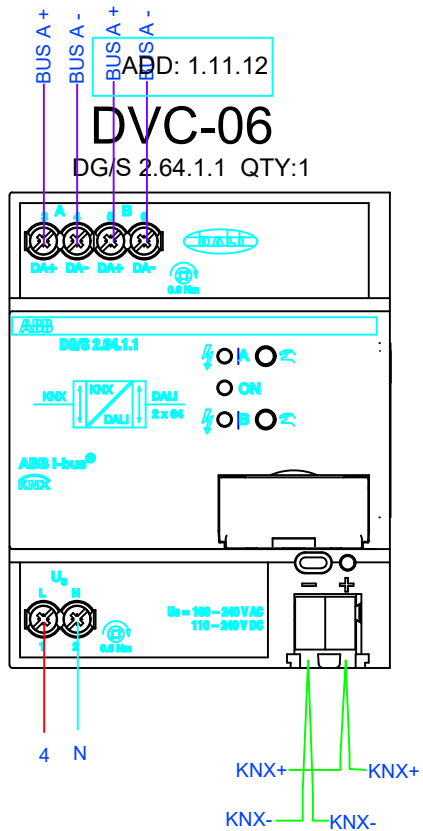

GENERAL NOTES:

System Integrator



OWNER:



CONSULTANT:



CONTRACTOR:



PROJECT TITLE:

HSBC Maadi Nile Courmich

DRAWING TITLE :

KNX PANEL SHOP DRAWINGS

DRAWING NUMBER :

EDB-BT

PAGE: 7/13

PREPARED BY: CHECKED BY: APPROVED BY:

DATE	REV.	PROJECT NO.	PAPER
Oct-2023	02	--	A4

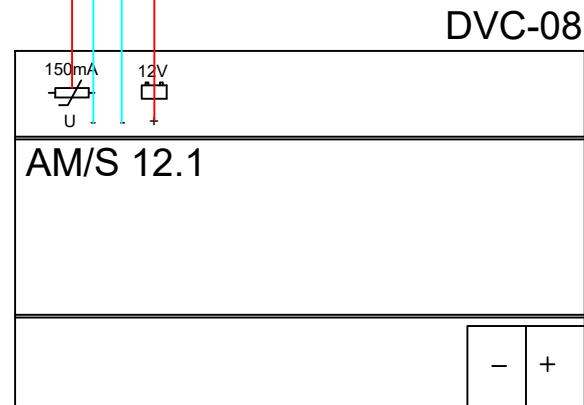
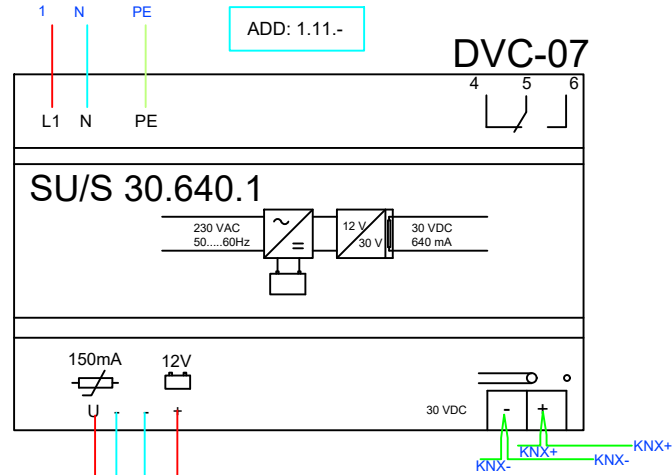

GENERAL NOTES:

System Integrator



OWNER:



CONSULTANT:



CONTRACTOR:



PROJECT TITLE:

HSBC Maadi Nile Courmich

DRAWING TITLE :

KNX PANEL SHOP DRAWINGS

DRAWING NUMBER :

EDB-BT

PAGE: 8/13

PREPARED BY:	CHECKED BY:	APPROVED BY:	
ENG. M.T	ENG. M.T	ENG. M.H	
DATE	REV.	PROJECT NO.	PAPER
Oct-2023	02	--	A4

ADD: 1.11.0

DVC-09
LK/S 4.2 QTY:1

DVC-10
AC/S 1.2.1 QTY:1

DATA PORT

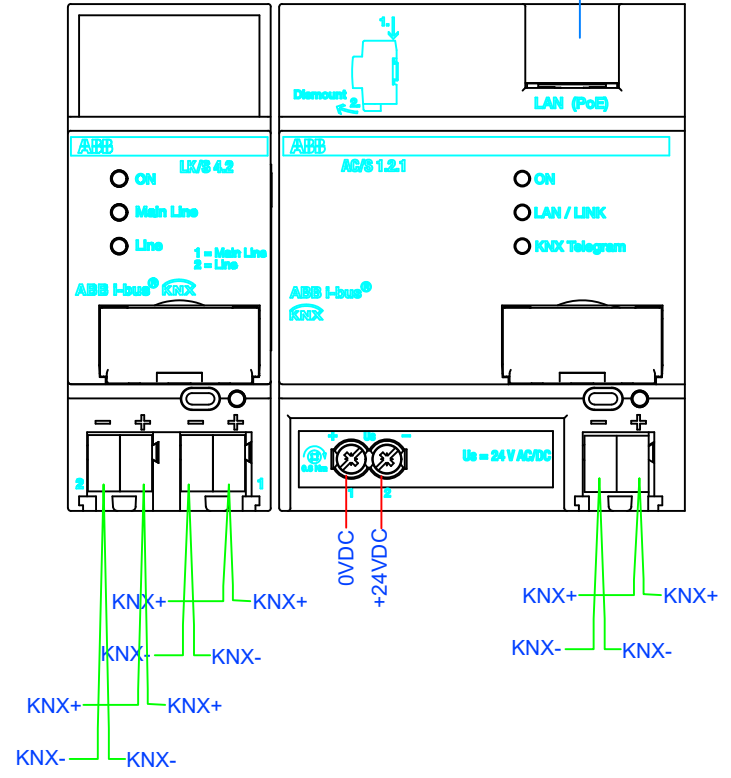

GENERAL NOTES:

System Integrator



OWNER:



CONSULTANT :



CONTRACTOR:



PROJECT TITLE:

HSBC Maadi Nile Courmich

DRAWING TITLE :

KNX PANEL SHOP DRAWINGS

DRAWING NUMBER :

EDB-BT

PAGE: 9/13

DATE	REV.	PROJECT NO.	PAPER
Oct-2023	02	--	A4

PREPARED BY:	CHECKED BY:	APPROVED BY:
ENG. M.T	ENG. M.T	ENG. M.H

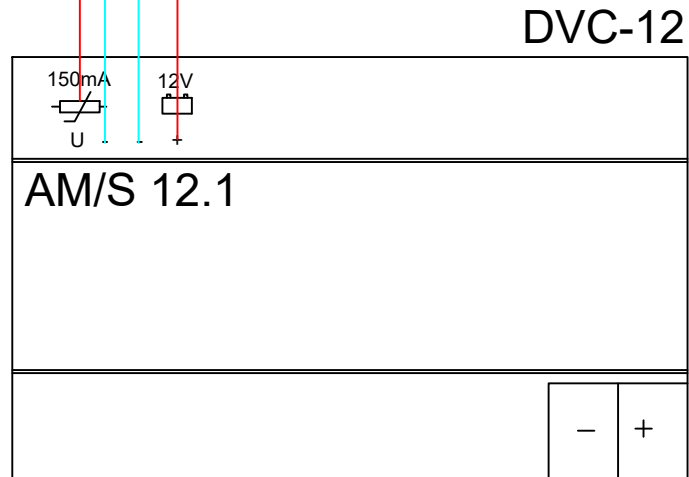
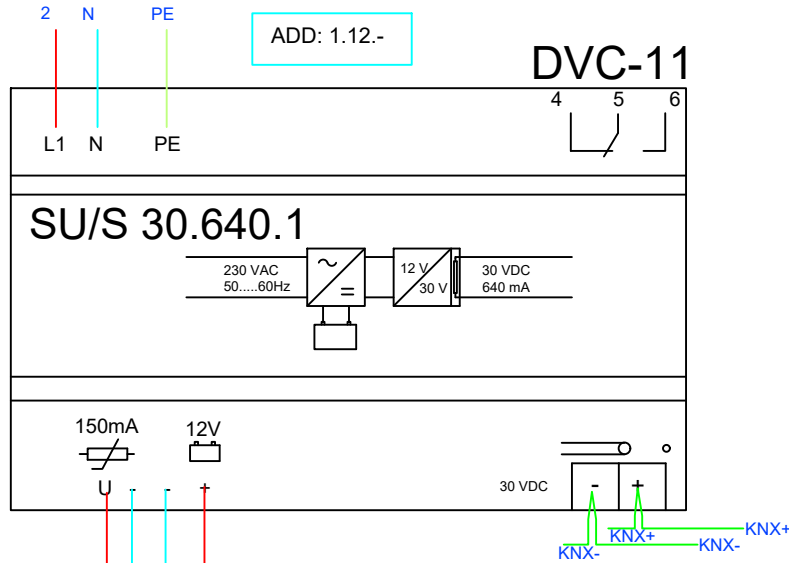

GENERAL NOTES:

System Integrator



OWNER:



CONSULTANT:



CONTRACTOR:



PROJECT TITLE:

HSBC Maadi Nile Courmich

DRAWING TITLE :

KNX PANEL SHOP DRAWINGS

DRAWING NUMBER :

EDB-BT

PAGE: 10/13

PREPARED BY:	CHECKED BY:	APPROVED BY:	
ENG. M.T	ENG. M.T	ENG. M.H	
DATE	REV.	PROJECT NO.	PAPER
Oct-2023	02	--	A4

GENERAL NOTES:

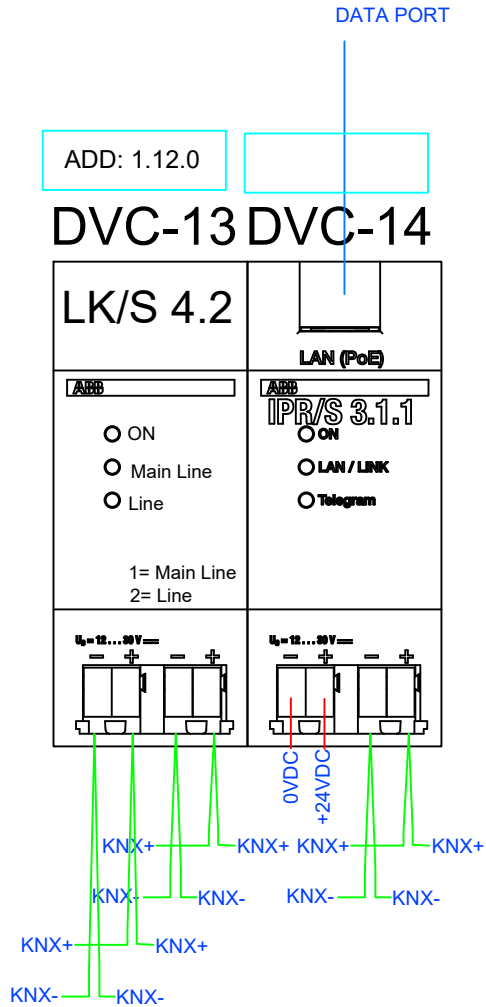

System Integrator



OWNER:



CONSULTANT:



CONTRACTOR:



PROJECT TITLE:

HSBC Maadi Nile Courmich

DRAWING TITLE :

KNX PANEL SHOP DRAWINGS

DRAWING NUMBER :

EDB-BT

PAGE: 11/13

PREPARED BY:	CHECKED BY:	APPROVED BY:	
ENG. M.T	ENG. M.T	ENG. M.H	
DATE	REV.	PROJECT NO.	PAPER
Oct-2023	02	--	A4

1	R1	To Load OF R1/CT1/1/EDB-BT
2	R1	To Load OF R1/CT1/1/EDB-BT
3	R1	To Load OF R1/CT1/3/EDB-BT
4	R1	To Load OF R1/CT1/4/EDB-BT
5	R1	To Load OF R1/CT1/5/EDB-BT
6	Y1	To Load OF Y1/CT1/7/EDB-BT
7	Y1	To Load OF Y1/CT1/8/EDB-BT
8	Y1	To Load OF Y1/CT1/9/EDB-BT
9	Y1	To Load OF Y1/CT1/10/EDB-BT
10	Y1	To Load OF Y1/CT1/11/EDB-BT
11	Y1	To Load OF Y1/CT1/12/EDB-BT
12	Y1	To Load OF Y1/CT1/13/EDB-BT
13	B1	To Load OF B1/CT1/14/EDB-BT
14	B1	To Load OF B1/CT1/15/EDB-BT
15	B1	To Load OF B1/CT1/16/EDB-BT
16	R2	To Load OF R2/CT1/17/EDB-BT
17	Y2	To Load OF Y2/CT1/18/EDB-BT
18	Y2	To Load OF Y2/CT1/19/EDB-BT
19	B2	To Load OF B2/CT1/20/EDB-BT
20	B2	To Load OF B2/CT1/21/EDB-BT
21	R3	To Load OF R3/CT1/22/EDB-BT
22	B3	To Load OF B3/CT1/23/EDB-BT
23	B3	To Load OF B3/CT1/24/EDB-BT
24	B3	To Load OF B3/CT1/25/EDB-BT
25	B3	To Load OF B3/CT1/26/EDB-BT
27	R4	To Load OF R4/CT1/27/EDB-BT
28	Y4	To Load OF Y4/CT1/EDB-BT
29	Y4	To Load OF Y4/CT1/EDB-BT
30	Y4	To Load OF Y4/CT1/EDB-BT
R1	R1	LINE OF R1/CT1/3/EDB-BT
R1	R1	LINE OF R1/CT1/4/EDB-BT
R1	R1	LINE OF R1/CT1/5/EDB-BT
Y1	Y1	LINE OF Y1/CT1/7/EDB-BT
Y1	Y1	LINE OF Y1/CT1/8/EDB-BT
Y1	Y1	LINE OF Y1/CT1/9/EDB-BT
Y1	Y1	LINE OF Y1/CT1/10/EDB-BT
Y1	Y1	LINE OF Y1/CT1/11/EDB-BT
Y1	Y1	LINE OF Y1/CT1/12/EDB-BT
Y1	Y1	LINE OF Y1/CT1/13/EDB-BT
Y1	Y1	LINE OF Y1/CT1/14/EDB-BT
B1	B1	LINE OF B1/CT1/14/EDB-BT
B1	B1	LINE OF B1/CT1/15/EDB-BT
R2	R2	LINE OF R2/CT1/17/EDB-BT
Y2	Y2	LINE OF Y2/CT1/18/EDB-BT
Y2	Y2	LINE OF Y2/CT1/19/EDB-BT
B2	B2	LINE OF B2/CT1/20/EDB-BT
B2	B2	LINE OF B2/CT1/21/EDB-BT
B2	B2	LINE OF B2/CT1/22/EDB-BT
R3	R3	LINE OF R3/CT1/22/EDB-BT
B3	B3	LINE OF B3/CT1/23/EDB-BT
B3	B3	LINE OF B3/CT1/24/EDB-BT
B3	B3	LINE OF B3/CT1/25/EDB-BT
B3	B3	LINE OF B3/CT1/26/EDB-BT
31	B4	To Load OF B4/CT1/1/EDB-BT
32	B4	To Load OF B4/CT1/2/EDB-BT
33	R5	To Load OF R5/CT1/3/EDB-BT
34		Space for load 34
35		Space
B4	B4	LINE OF B4/CT1/1/EDB-BT
B4	B4	LINE OF B4/CT1/2/EDB-BT
R5	R5	LINE OF R5/CT1/3/EDB-BT
		Space for load 35
	R7	TO POWER SUPPLY LINE 1 R7/CT1/EDB-BT
	N	TO POWER SUPPLY LINE 1 R7/CT1/EDB-BT
	PE	TO POWER SUPPLY LINE 1 R7/CT1/EDB-BT
	R7	TO POWER SUPPLY LINE 2 R7/CT1/EDB-BT
	N	TO POWER SUPPLY LINE 2 R7/CT1/EDB-BT
	PE	TO POWER SUPPLY LINE 2 R7/CT1/EDB-BT
	R7	TO POWER SUPPLY LINE 3 R7/CT1/EDB-BT
	N	TO POWER SUPPLY LINE 3 R7/CT1/EDB-BT
	R7	TO POWER SUPPLY LINE 3 R7/CT1/EDB-BT
	N	TO POWER SUPPLY LINE 3 R7/CT1/EDB-BT
	N	TO POWER SUPPLY LINE 3 R7/CT1/EDB-BT
	E	1 x 10 panel Earth view

DALI

DVC-01
SAS 12.16.6.2/1
ADD: 1.11.9

DVC-02
SAS 4.16.6.2
ADD: 1.11.10

DVC-03
SAS 12.16.6.2/1
ADD: 1.11.11

DALI

DVC-01
SAS 12.16.6.2/1
ADD: 1.11.9

DVC-02
SAS 4.16.6.2
ADD: 1.11.10

DVC-03
SAS 12.16.6.2/1
ADD: 1.11.11

DVC-03
SAS 12.16.6.2/1
ADD: 1.11.11

DVC-07
SUS 30.640.1
ADD: 1.11.1

DVC-11
SUS 30.640.1
ADD: 1.12.1

DVC-05
ADD: 1.12.1

GENERAL NOTES:

System Integrator



OWNER:



CONSULTANT:



CONTRACTOR:



PROJECT TITLE:

HSBC Maadi Nile Council

DRAWING TITLE :

KNX PANEL SHOP DRAWINGS

DRAWING NUMBER :

EDB-BT

PAGE: 12/13

PREPARED BY:	CHECKED BY:	APPROVED BY:
ENG. M.T	ENG. M.T	ENG. M.H
DATE	REV.	PROJECT NO.
Oct-2023	02	--
		PAPER
		A4

HSBC 6th floor

		NUMBER OF RETURNS CONTROLLED BY PRESENCE SENSOR ONLY / PIR & LIGHTING SWITCH / LIGHTING SWITCH ONLY	CIRCUIT COLOR	CIRCUIT NO.	RETURNS NO. FOR EACH CIRCUIT	LOCATION	NUMBER OF DALI LIGHTING FIXTURES (DALI DRIVER)	Actuator Address	Actuator Channel	PRESENCE SENSOR	KEYPAD & TOUCH SCREEN	
6TH FLOOR	EDB-BT	33	R1	CT1	1	DALI Parent A L06-637	1	DVC-06			46	One TOUCH SCREEN IN ELEC ROOM G-143 and 7 keypads
					2	DALI Parent A L06-637	1	1.11.12				
					3	DOCTOR L06-636			A			
					4	room between doctor room & storage		1.11.9	B			
					5	FURNITURE STORAGE L06-638			C			
			Y1	CT2	6	TOILET LOBBY				D		
					7	DISABLED TOILET L06-627			E			
					8	SHOWER L06-626			F			
					9	SHOWER LOBBY		DVC-01	G			
					10	Female Toilet L06-629		1.11.9	H			
					11	STAIRS LOBBY L06-650			I			
					12	ELEC ROOM L06-649			J			
			B1	CT3	13	IT EXPRESS CENTER L06-633				K		
					14	IT CAGE L06-634		1.11.9	L			
					15	IT EXPRESS CENTER L06-633		1.11.10	A			
			R2	CT4	16	50P TOWNHALL L06-646			DVC-02	B		
			Y2	CT5	17	50P TOWNHALL L06-645			1.11.10	C		
					18	AUDIO VISUAL CONTROL ROOM L06-644			D			
			B2	CT6	19	CIRCULATION L06-647			DVC-03	A		
					20			B				
			R3	CT7	21	STAIRS L06-652			1.11.11	C		
					22	PANTRY L06-632			D			
					23	CIRCULATION L06-647			E			
			B3	CT9	24	FURNITURE STORAGE L06-648				F		
					25	CIRCULATION L06-647			G			
					26	DALI 6P MEETING ROOM L06-643	1					
			R4	CT10	27	DALI 12P MEETING ROOM L06-642	1					
					28	DALI 4P MEETING ROOM L06-641	1	DVC-06				
			Y4	CT11	29	DALI 6P MEETING ROOM 6P MEETING ROOM	1		1.11.12			
					30	DALI 6P MEETING ROOM L06-639	1					
					31					H		
			B4	CT12	32	CIRCULATION L06-647				I		
					33	LIFTS LOBBY L06-622			DVC-03	J		
			R5	CT13	34	Spare			1.11.11	K		
			Y5		35	Spare				L		

GENERAL NOTES:

System Integrator



OWNER:



CONSULTANT:



CONTRACTOR:



PROJECT TITLE:
 HSBC Maadi Nile Courch

DRAWING TITLE :
 KNX PANEL SHOP DRAWINGS

DRAWING NUMBER :
 EDB-BT
 PAGE: 13/13

PREPARED BY:	CHECKED BY:	APPROVED BY:
ENG. M.T	ENG. M.T	ENG. M.H
DATE	REV.	PROJECT NO.
Oct-2023	02	--
		PAPER
		A4

DB-AT Sixth Floor

GENERAL NOTES:

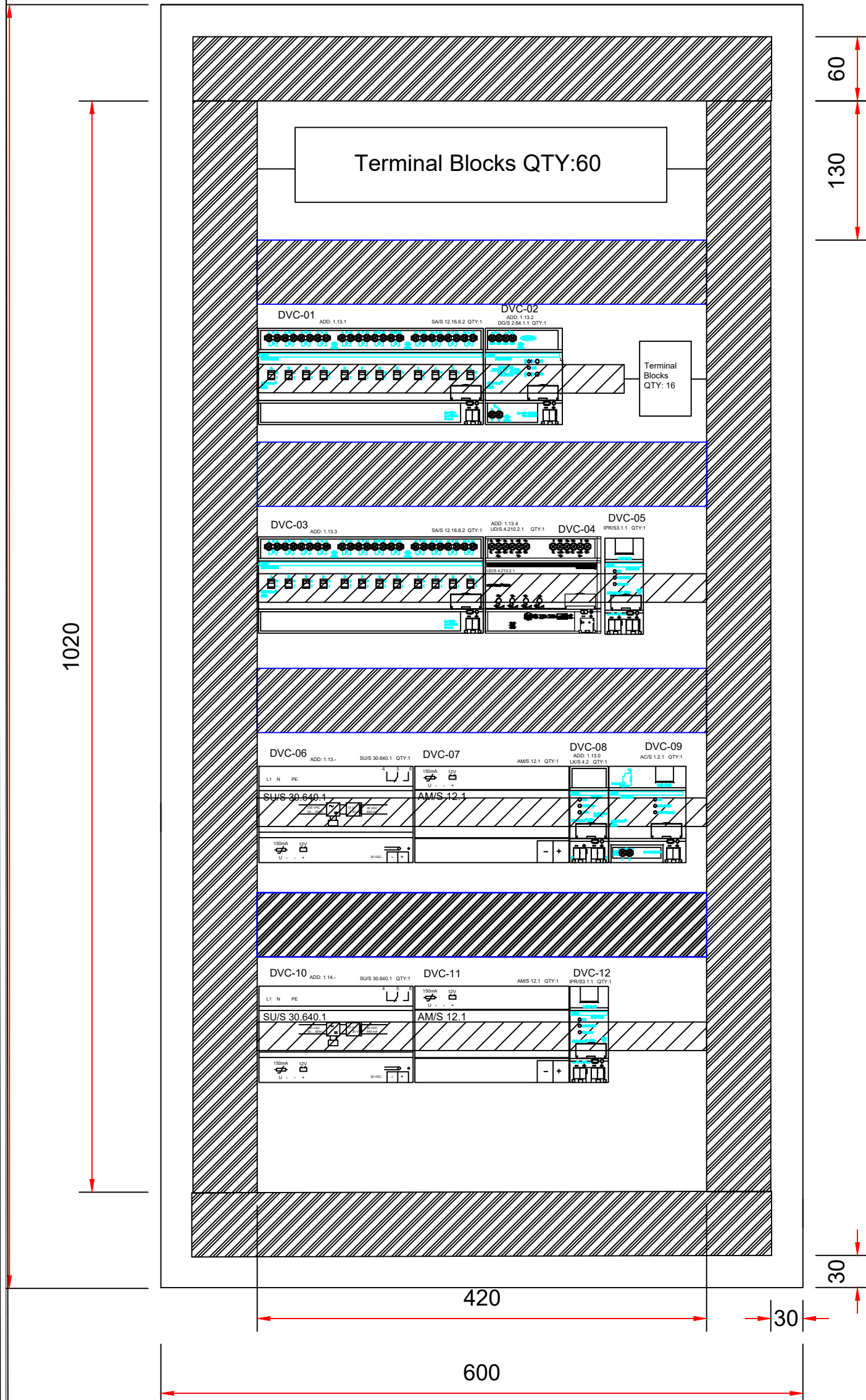

System Integrator



OWNER:



CONSULTANT :



CONTRACTOR:



PROJECT TITLE:

HSBC Maadi Nile Cournich

DRAWING TITLE :

KNX PANEL SHOP DRAWINGS

DRAWING NUMBER :

DB-AT

PAGE: 1/12

PREPARED BY:	CHECKED BY:	APPROVED BY:
ENG. M.T	ENG.M.T	ENG.M.H
DATE	REV.	PROJECT NO.
Oct-2023	02	--
		PAPER
		A3

DVC-01

SAS 12.16.6.2/1 QTY:1 ADD: 1.11.1

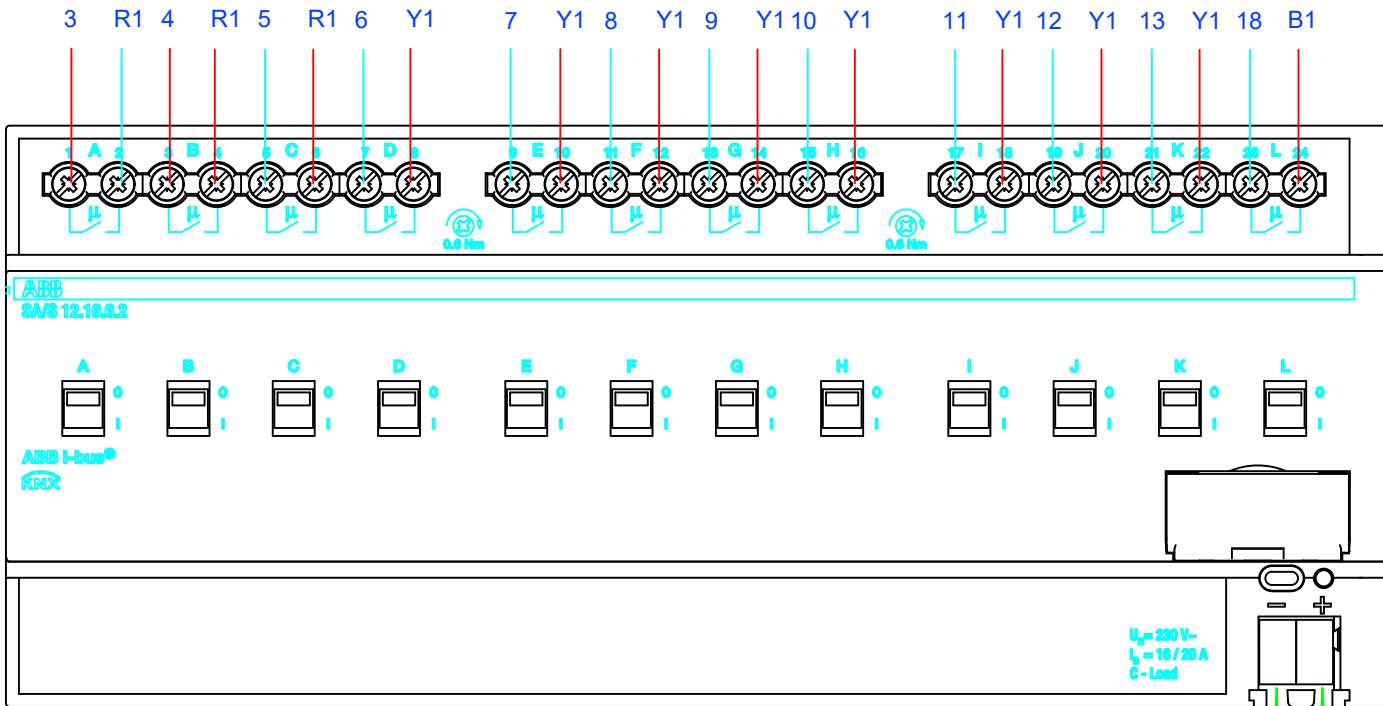

KNX+ ——— KNX+
 KNX- ——— KNX-

GENERAL NOTES:

System Integrator

OWNER:

CONSULTANT:

CONTRACTOR:

PROJECT TITLE:
 HSBC Maadi Nile Courch

DRAWING TITLE :
 KNX PANEL SHOP DRAWINGS

DRAWING NUMBER :
 DB-AT

PAGE: 2/12

PREPARED BY:	CHECKED BY:	APPROVED BY:	
ENG. M.T	ENG. M.T	ENG. M.H	
DATE	REV.	PROJECT NO.	PAPER
Oct-2023	02	--	A4

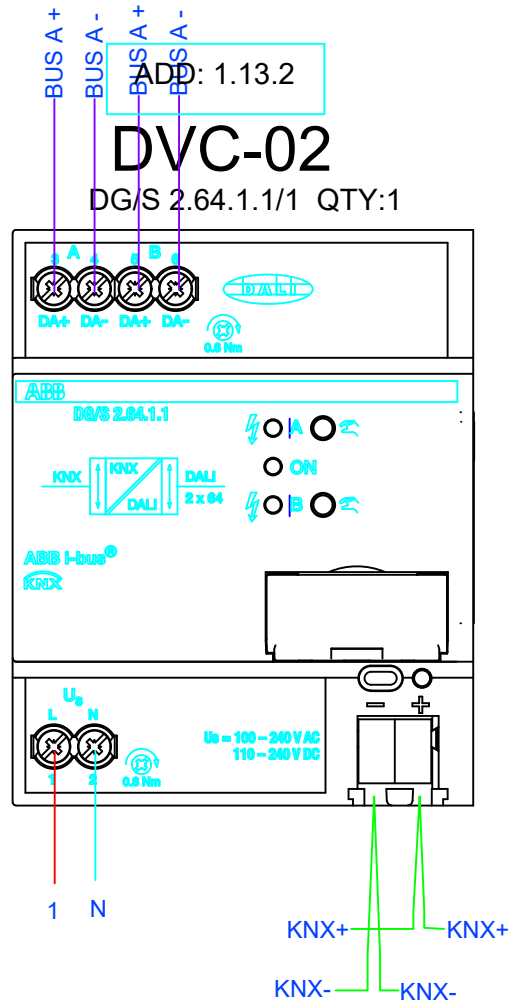

GENERAL NOTES:

System Integrator



OWNER:



CONSULTANT:



CONTRACTOR:



PROJECT TITLE:

HSBC Maadi Nile Courmich

DRAWING TITLE :

KNX PANEL SHOP DRAWINGS

DRAWING NUMBER :

DB-AT

PAGE: 3/12

PREPARED BY:	CHECKED BY:	APPROVED BY:	
ENG. M.T	ENG. M.T	ENG. M.H	
DATE	REV.	PROJECT NO.	PAPER
Oct-2023	02	--	A4

DVC-03

SAS 12.16.6.2/2 QTY:1

ADD: 1.13.3

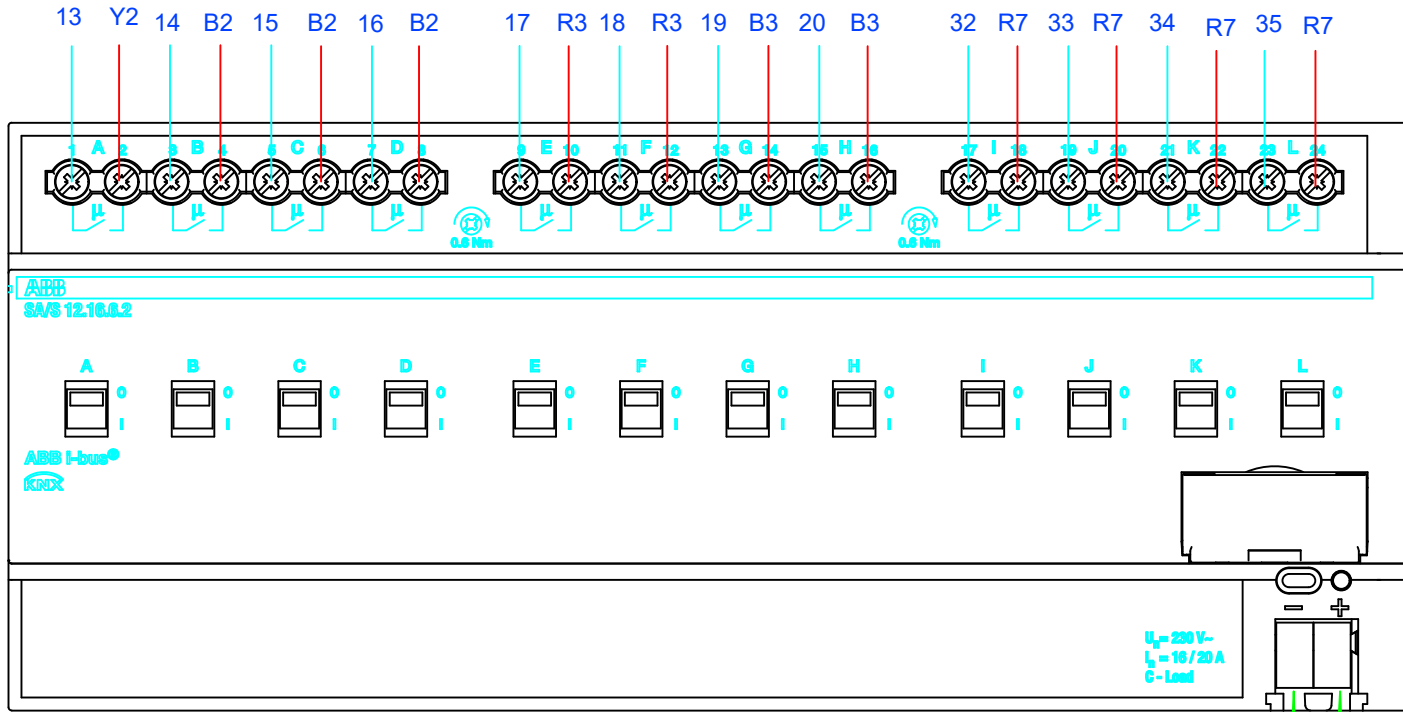

GENERAL NOTES:

System Integrator



OWNER:



CONSULTANT:



CONTRACTOR:



PROJECT TITLE:

HSBC Maadi Nile Courch

DRAWING TITLE :

KNX PANEL SHOP DRAWINGS

DRAWING NUMBER :

DB-AT

PAGE: 4/12

PREPARED BY:	CHECKED BY:	APPROVED BY:	
ENG. M.T	ENG. M.T	ENG. M.H	
DATE	REV.	PROJECT NO.	PAPER
Oct-2023	02	-	A4

ADD: 1.13.4

UD/S 4.210.2.1 QTY:1 **DVC-04**

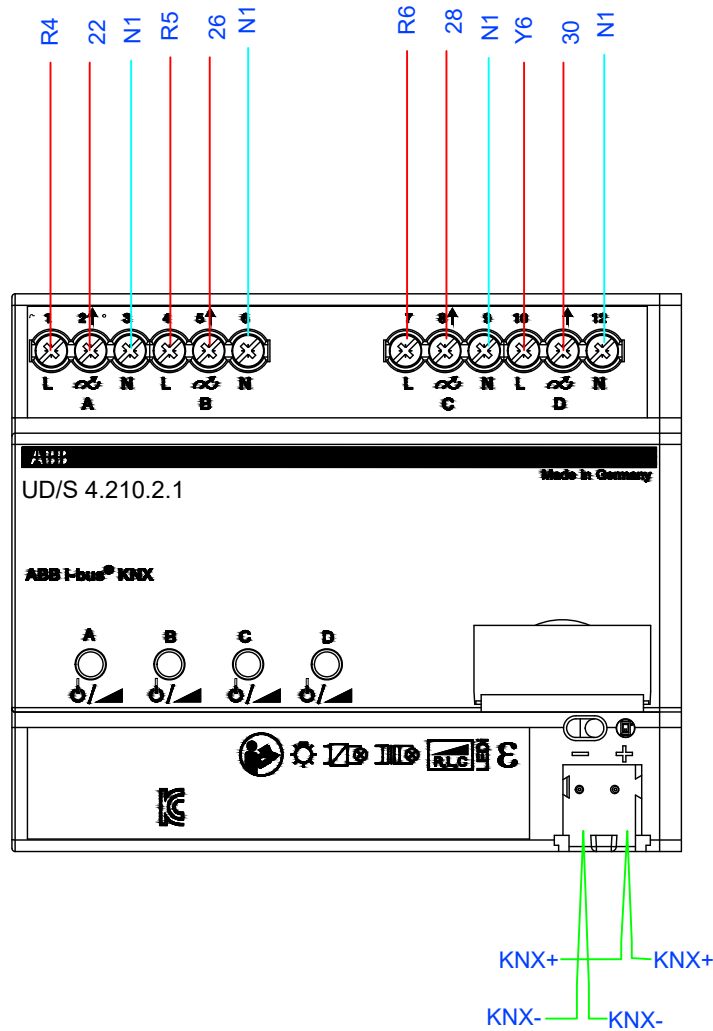

GENERAL NOTES:

System Integrator



OWNER:



CONSULTANT:



CONTRACTOR:



PROJECT TITLE:

HSBC Maadi Nile Courmich

DRAWING TITLE :

KNX PANEL SHOP DRAWINGS

DRAWING NUMBER :

DB-AT

PAGE: 5/12

PREPARED BY:	CHECKED BY:	APPROVED BY:	
ENG. M.T	ENG. M.T	ENG. M.H	
DATE	REV.	PROJECT NO.	PAPER
Oct-2023	02	--	A4

DATA PORT

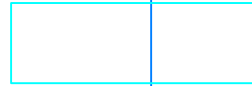

DVC-05

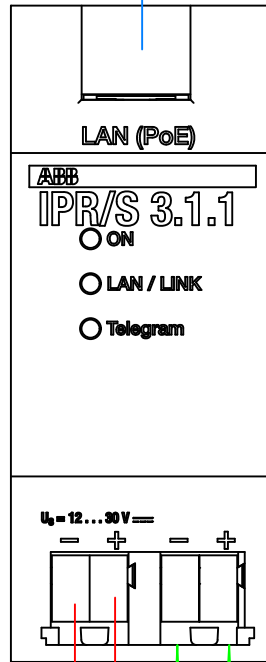

0VDC
+24VDC

KNX+ KNX+
KNX- KNX-

GENERAL NOTES:

System Integrator



OWNER:



CONSULTANT:



CONTRACTOR:



PROJECT TITLE:

HSBC Maadi Nile Courmich

DRAWING TITLE :

KNX PANEL SHOP DRAWINGS

DRAWING NUMBER :

DB-AT

PAGE: 6/12

PREPARED BY:	CHECKED BY:	APPROVED BY:	
ENG. M.T	ENG. M.T	ENG. M.H	
DATE	REV.	PROJECT NO.	PAPER
Oct-2023	02	--	A4

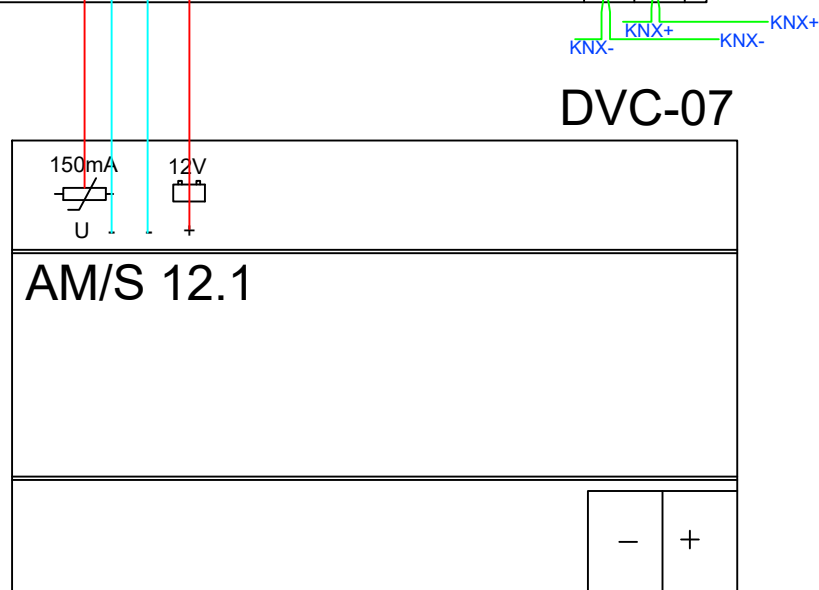
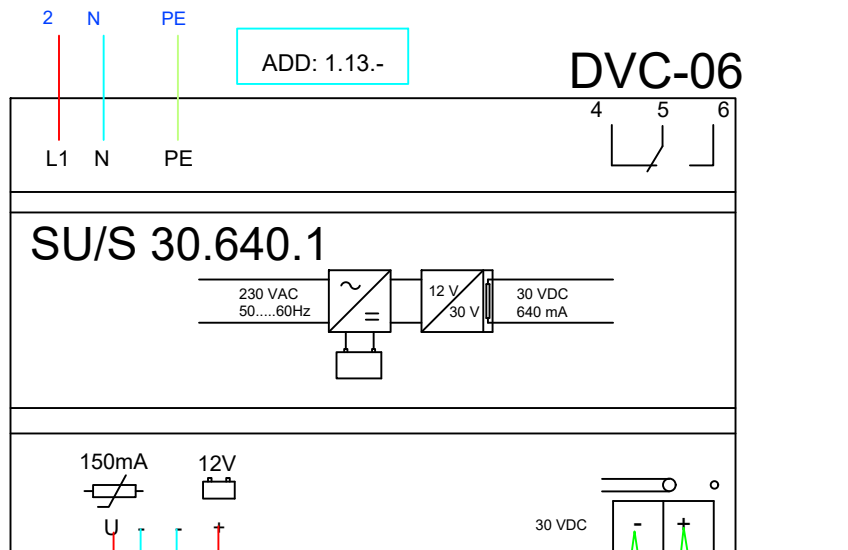

GENERAL NOTES:

System Integrator



OWNER:



CONSULTANT:



CONTRACTOR:



PROJECT TITLE:

HSBC Maadi Nile Courmich

DRAWING TITLE :

KNX PANEL SHOP DRAWINGS

DRAWING NUMBER :

DB-AT

PAGE: 7/12

PREPARED BY:	CHECKED BY:	APPROVED BY:	
ENG. M.T	ENG. M.T	ENG. M.H	
DATE	REV.	PROJECT NO.	PAPER
Oct-2023	02	--	A4

ADD: 1.13.0

DVC-08

LK/S 4.2 QTY:1

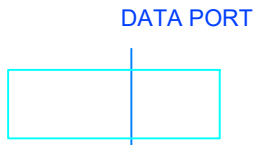

DVC-09

AC/S 1.2.1 QTY:1

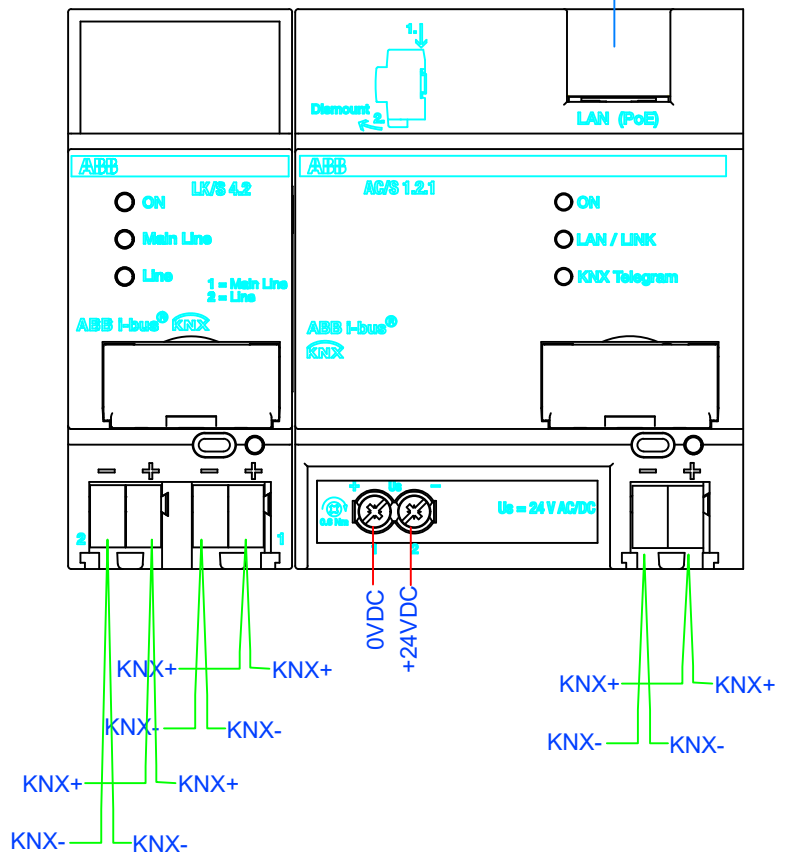

GENERAL NOTES:

System Integrator



OWNER:



CONSULTANT:



CONTRACTOR:



PROJECT TITLE:

HSBC Maadi Nile Courmich

DRAWING TITLE :

KNX PANEL SHOP DRAWINGS

DRAWING NUMBER :

DB-AT

PAGE: 8/12

PREPARED BY:	CHECKED BY:	APPROVED BY:	
ENG. M.T	ENG. M.T	ENG. M.H	
DATE	REV.	PROJECT NO.	PAPER
Oct-2023	02	--	A4

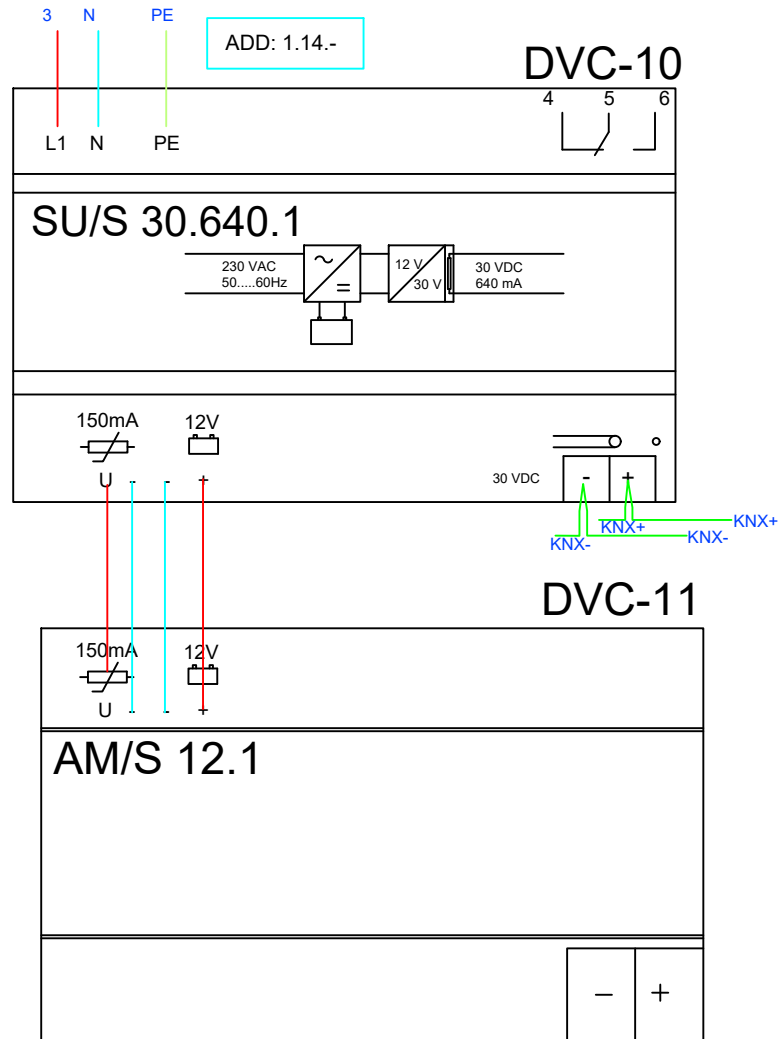

GENERAL NOTES:

System Integrator



OWNER:



CONSULTANT:



CONTRACTOR:



PROJECT TITLE:

HSBC Maadi Nile Courmich

DRAWING TITLE :

KNX PANEL SHOP DRAWINGS

DRAWING NUMBER :

DB-AT

PAGE: 9/12

PREPARED BY:	CHECKED BY:	APPROVED BY:	
ENG. M.T	ENG. M.T	ENG. M.H	
DATE	REV.	PROJECT NO.	PAPER
Oct-2023	02	--	A4

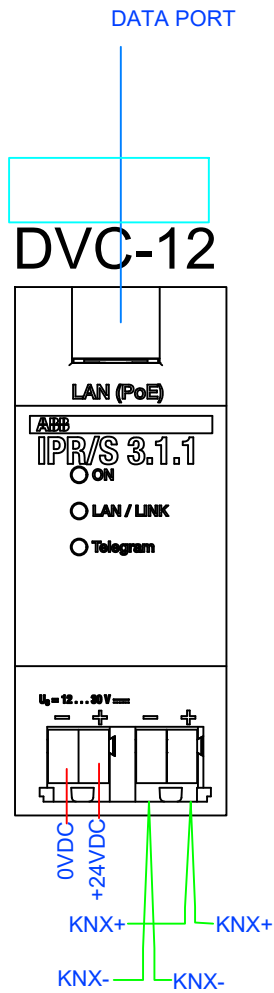

GENERAL NOTES:

System Integrator



OWNER:



CONSULTANT:



CONTRACTOR:



PROJECT TITLE:

HSBC Maadi Nile Courmich

DRAWING TITLE :

KNX PANEL SHOP DRAWINGS

DRAWING NUMBER :

DB-AT

PAGE: 10/12

PREPARED BY: CHECKED BY: APPROVED BY:

DATE	REV.	PROJECT NO.	PAPER
Oct-2023	02	--	A4

1	1		
2	2		
3	3		
4	4		
5	5		
6	6		
7	7		
8	8		
9	9		
10	10		
11	11		
12	12		
13	13		
14	14		
15	15		
16	16		
17	17		
18	18		
19	19		
20	20		
32	32		
33	33		
34	34		
35	35		
R1	R1		
Y1	Y1		
Y1	Y1		
Y1	Y1		
B1	B1		
B1	B1		
B1	B1		
B1	B1		
B1	B1		
R2	R2		
Y2	Y2		
Y2	Y2		
B2	B2		
B2	B2		
B2	B2		
R3	R3		
R3	R3		
B3	B3		
R7	R7		
R7	R7		
R7	R7		
R4	R4		
N	N		
N	N		
R5	R5		
26	26		
N	N		
R6	R6		
28	28		
N	N		
N	N		
Y6	Y6		
30	30		
N	N		
N	N		
B5	B5		
36	36		
N	N		
B6	B6		
37	37		
N	N		
N	N		
LR4	R4		
LY4	Y4		
LB4	B4		
LR5	R5		
LY5	Y5		
LY6	Y6		
LY7	Y7		
R12	R12		
N	N		
PE	PE		
PE	PE		
R12	R12		
N	N		
PE	PE		
R12	R12		
N	N		
N	N		
E	E		



DVC-01
SA/S 12.16.6.2/1
ADD: 1.13.1

DVC-03
SA/S 12.16.6.2/1
ADD: 1.13.3

DVC-01
SA/S 12.16.6.2/1
ADD: 1.13.1

DVC-03
SA/S 12.16.6.2/1
ADD: 1.13.3

DVC-04
UD/S 4.210.2.1
ADD: 1.13.4

DALI

DVC-06
SU/S 30.640.1
400 114

DVC-10
SU/S 30.640.1
400 114

GENERAL NOTES:

System Integrator



OWNER:



CONSULTANT:



CONTRACTOR:



PROJECT TITLE:

HSBC Maadi Nile Council

DRAWING TITLE :

KNX PANEL SHOP DRAWINGS

DRAWING NUMBER :

DB-AT

PAGE: 11/12

PREPARED BY:	CHECKED BY:	APPROVED BY:
ENG. M.T	ENG. M.T	ENG. M.H
DATE	REV.	PROJECT NO.
Oct-2023	02	--
		PAPER
		A4

HSBC 6th floor

		NUMBER OF RETURNS CONTROLLED BY PRESENCE SENSOR ONLY / PIR & LIGHTING SWITCH / LIGHTING SWITCH ONLY	CIRCUIT COLOR	CIRCUIT NO.	RETURNS NO. FOR EACH CIRCUIT	LOCATION	NUMBER OF DALI LIGHTING FIXTURES (DALI DRIVER)	Actuator Address	Actuator Channel	PRESENCE SENSOR	KEYPAD & TOUCH SCREEN	
6TH FLOOR	DB-AT	31		R1	CT1	1	24P HR TRAINING L06-635	DVC-01 1.13.1	A	53	2 KEYPADS	
				Y1	CT2	2	PRAYER ROOM L06-612		B			
						3	FURNITURE STORAGE L06-615		C			
						4	12P HR TRAINING L06-624		D			
						5	SHOE RACKS L06-614		E			
				B1	CT3	6	ABLUTION ROOM L06-613		F			
						7	ABLUTION ROOM L06-611		G			
						8	SHOE RACKS L06-610		H			
						9	PRAYER ROOM L06-609		I			
				R2	CT4	10	12P HR TRAINING L06-625		J			
				Y2	CT5	11	SHOWER L06-623	1.13.1	K			
						12	TOILET LOBBY	L				
						13	Male Toilet L06-620	1.13.3	A			
				B2	CT6	14	CAFÉ L06-602	DVC-02 1.13.3	B			
						15	KITCHEN STORE L06-603		C			
						16	CIRCULATION L06-606		D			
				R3	CT7	17	RESTAURANT L06-608		E			
						18	PREP L06-607		F			
				Y3	CT8	LIFE	RISERS		G			
				B3	CT9	19	CIRCULATION L06-647	H				
						20		I				
				R7		32	Spare	J				
						33		K				
						34		L				
						35						
				R4	CT10	21	CAFETERIA L06-601	18	DVC-02 1.13.2			A
						22			DVC-04 1.13.4			
				Y4	CT11	23	CAFETERIA L06-601	16	1.13.2			
				B4	CT12	24	CAFETERIA L06-601	7	1.13.2			
				R5	CT13	25	CAFETERIA L06-601	10	1.13.2			B
26	1.13.4											
Y5	CT14	27	CAFETERIA L06-601	11	1.13.2							
R6	CT16	28	CAFETERIA L06-601		1.13.4	C						
Y6	CT17	29	CAFETERIA L06-601	17	1.13.2	D						
		30		1.13.4								
Y7	CT20	31	CAFETERIA L06-601	11	1.13.2							

GENERAL NOTES:

System Integrator



OWNER:



CONSULTANT :



CONTRACTOR:



PROJECT TITLE:

HSBC Maadi Nile Courch

DRAWING TITLE :

KNX PANEL SHOP DRAWINGS

DRAWING NUMBER :

DB-AT

PAGE: 12/12

PREPARED BY: _____ CHECKED BY: _____ APPROVED BY: _____

ENG. M.T	ENG. M.T	ENG. M.H
DATE	REV.	PROJECT NO.
Oct-2023	02	--
		PAPER
		A4

EDB-AT

Sixth Floor

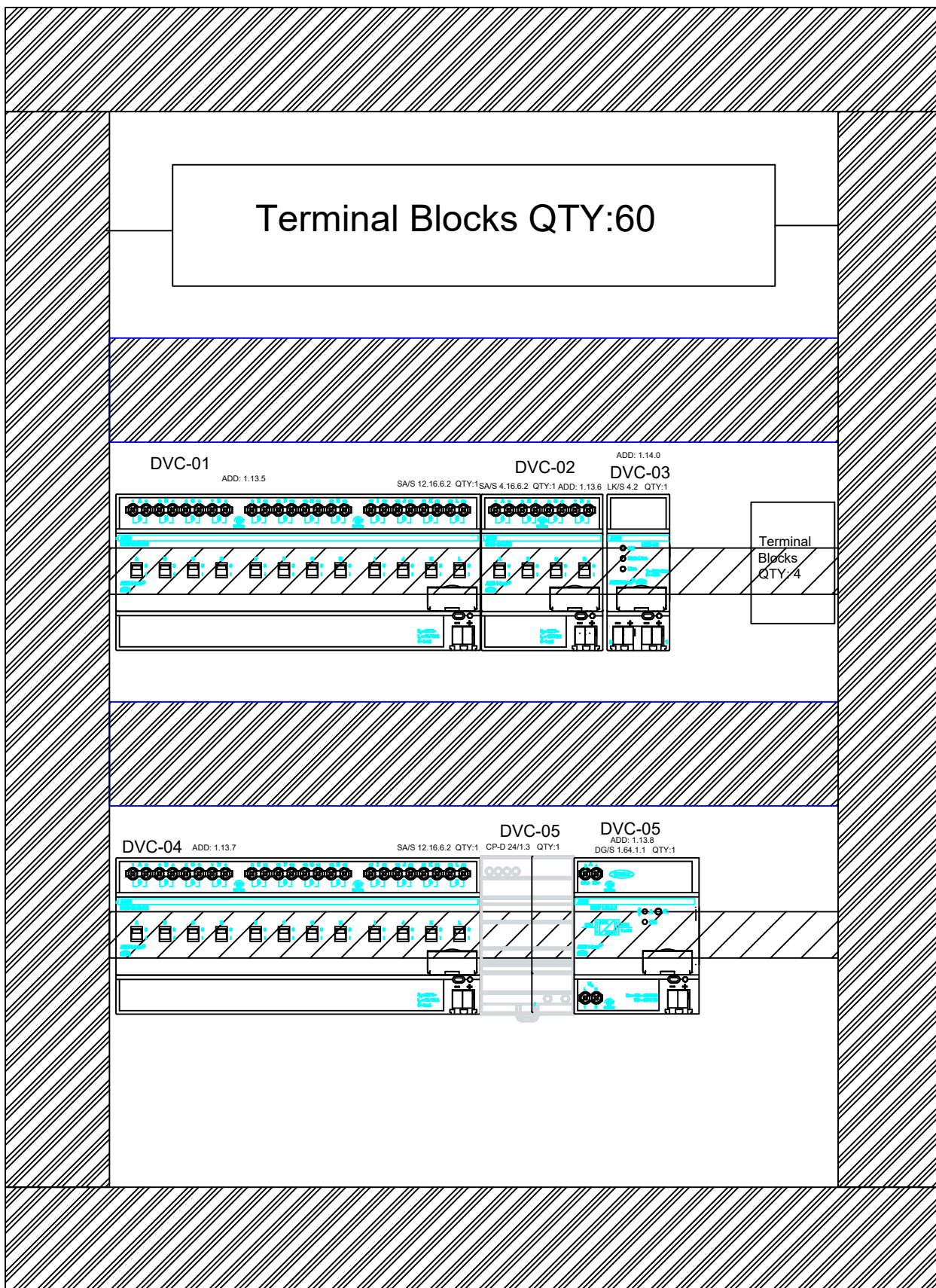

GENERAL NOTES:

System Integrator



OWNER:



CONSULTANT :



CONTRACTOR:



PROJECT TITLE:

HSBC Maadi Nile Courmich

DRAWING TITLE :

KNX PANEL SHOP DRAWINGS

DRAWING NUMBER :

EDB-AT

PAGE: 1/9

PREPARED BY:	CHECKED BY:	APPROVED BY:	
ENG. M.T	ENG.M.T	ENG.M.H	
DATE	REV.	PROJECT NO.	PAPER
Oct-2023	02	--	A3

DVC-01

SAS 12.16.6.2/1 QTY:1

ADD: 1.13.5

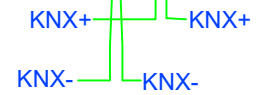
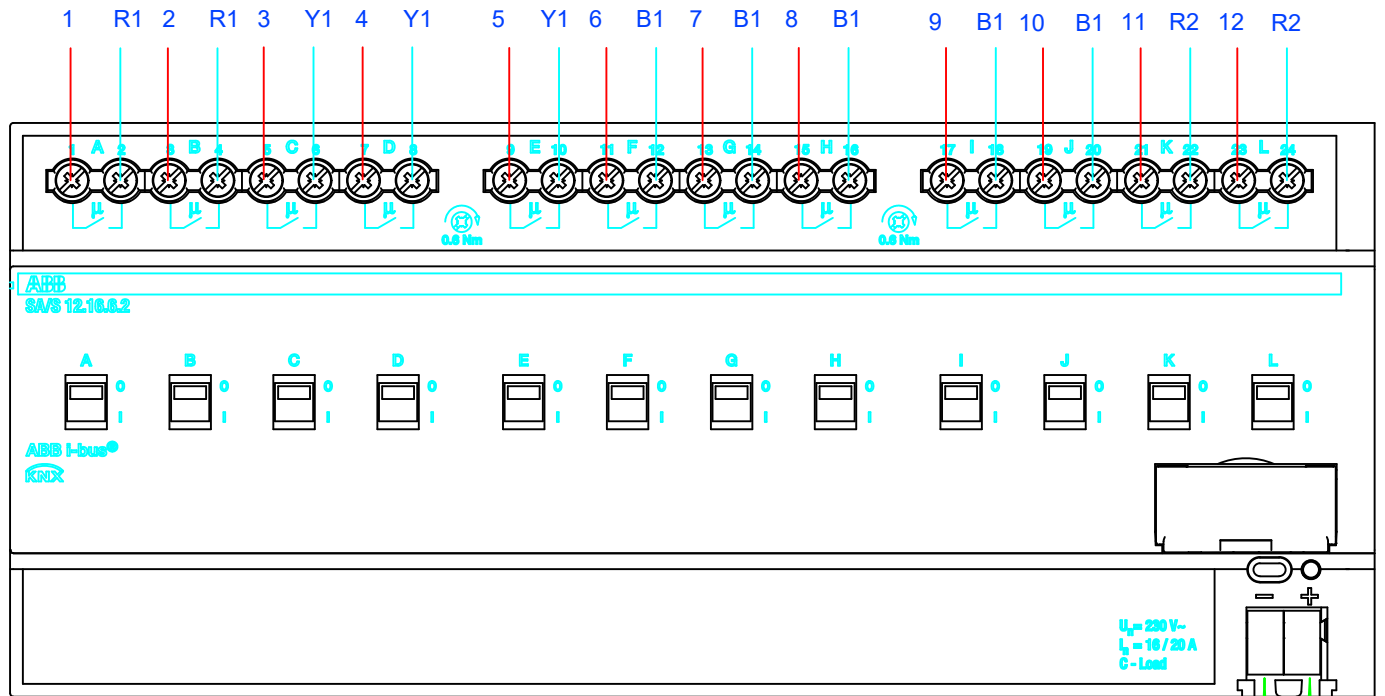

GENERAL NOTES:

System Integrator

OWNER:

CONSULTANT:

CONTRACTOR:

PROJECT TITLE:
 HSBC Maadi Nile Courmich

DRAWING TITLE :
 KNX PANEL SHOP DRAWINGS

DRAWING NUMBER :
 EDB-AT
 PAGE: 2/9

DATE	REV.	PROJECT NO.	PAPER
Oct-2023	02	-	A4

ADD: 1.13.6

DVC-02

SA/S 4.16.6.2 QTY:1

13 Y2 14 Y2 15 Y2 16 Y2

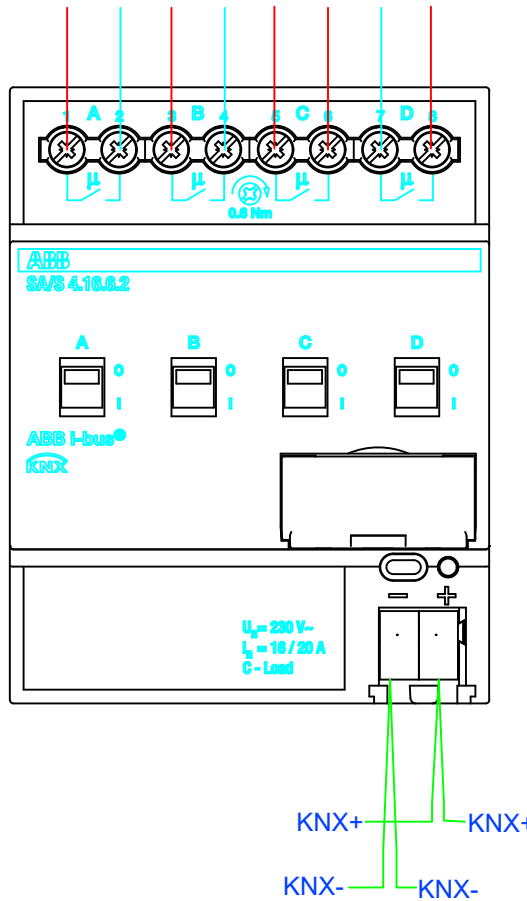

GENERAL NOTES:

System Integrator

OWNER:

CONSULTANT:

CONTRACTOR:

PROJECT TITLE:
HSBC Maadi Nile Courmich

DRAWING TITLE :
KNX PANEL SHOP DRAWINGS

DRAWING NUMBER :
EDB-AT
PAGE: 3/9

PREPARED BY:	CHECKED BY:	APPROVED BY:
ENG. M.T	ENG. M.T	ENG. M.H
DATE	REV.	PROJECT NO.
Oct-2023	02	--

PAPER
A4

ADD: 1.14.0

DVC-03

LK/S 4.2

ABB

- ON
- Main Line
- Line

1= Main Line
2= Line

$U_0 = 12 \dots 30V =$

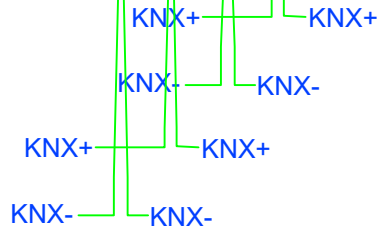
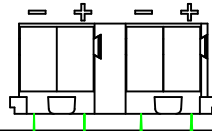

GENERAL NOTES:

System Integrator



OWNER:



CONSULTANT:



CONTRACTOR:



PROJECT TITLE:

HSBC Maadi Nile Courmich

DRAWING TITLE :

KNX PANEL SHOP DRAWINGS

DRAWING NUMBER :

EDB-AT

PAGE: 4/9

PREPARED BY:	CHECKED BY:	APPROVED BY:	
ENG. M.T	ENG. M.T	ENG. M.H	
DATE	REV.	PROJECT NO.	PAPER
Oct-2023	02	--	A4

ADD: 1.13.7

DVC-04

SA/S 12.16.6.2/2 QTY:1



ABB
SA/S 12.16.6.2



ABB I-bus
KNX

$U_n = 230 V-$
 $I_n = 16 / 20 A$
C-Load

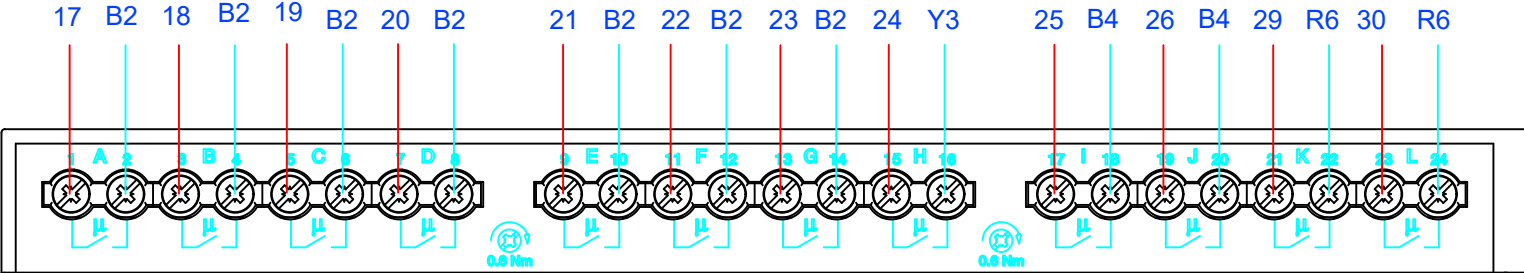

GENERAL NOTES:

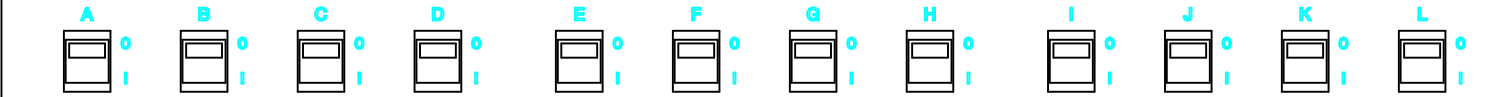
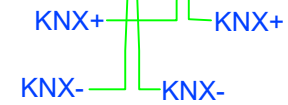
System Integrator



OWNER:



CONSULTANT:



CONTRACTOR:



PROJECT TITLE:

HSBC Maadi Nile Courmich

DRAWING TITLE :

KNX PANEL SHOP DRAWINGS

DRAWING NUMBER :

EDB-AT

PAGE: 5/9

PREPARED BY:	CHECKED BY:	APPROVED BY:
ENG. M.T	ENG. M.T	ENG. M.H
DATE	REV.	PROJECT NO.
Oct-2023	02	--
		PAPER
		A4

DVC-05

CP-D 24/1.3 QTY:1

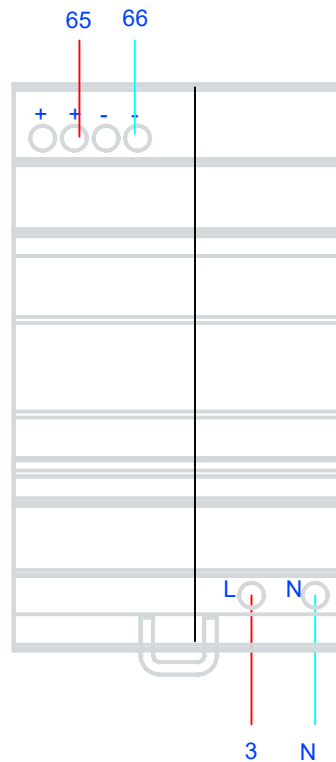

GENERAL NOTES:

System Integrator



OWNER:



CONSULTANT:



CONTRACTOR:



PROJECT TITLE:

HSBC Maadi Nile Courmich

DRAWING TITLE :

KNX PANEL SHOP DRAWINGS

DRAWING NUMBER :

EDB-AT

PAGE: 6/9

PREPARED BY: CHECKED BY: APPROVED BY:

ENG. M.T	ENG. M.T	ENG. M.H
DATE	REV.	PROJECT NO.
Oct-2023	02	--

PAPER

A4

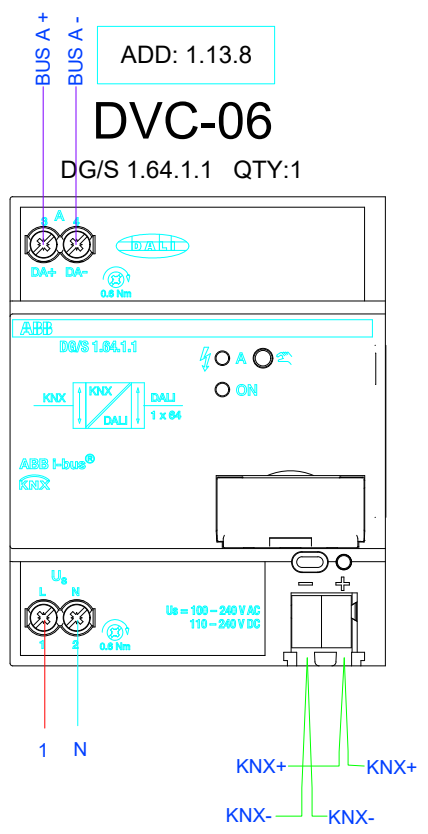

GENERAL NOTES:

System Integrator



OWNER:



CONSULTANT:



CONTRACTOR:



PROJECT TITLE:

HSBC Maadi Nile Courmich

DRAWING TITLE :

KNX PANEL SHOP DRAWINGS

DRAWING NUMBER :

EDB-AT

PAGE: 7/9

PREPARED BY: CHECKED BY: APPROVED BY:

DATE	REV.	PROJECT NO.	PAPER
JULY-2023	02	--	A4

1	R1	To Load OF R1/C111/EDB-AT
2	R1	To Load OF R1/C112/EDB-AT
3	Y1	To Load OF Y1/C123/EDB-AT
4	Y1	To Load OF Y1/C124/EDB-AT
5	Y1	To Load OF Y1/C125/EDB-AT
6	B1	To Load OF B1/C136/EDB-AT
7	B1	To Load OF B1/C137/EDB-AT
8	B1	To Load OF B1/C138/EDB-AT
9	B1	To Load OF B1/C139/EDB-AT
10	B1	To Load OF B1/C140/EDB-AT
11	R2	To Load OF R2/C141/EDB-AT
12	R2	To Load OF R2/C142/EDB-AT
13	Y2	To Load OF Y2/C153/EDB-AT
14	Y2	To Load OF Y2/C154/EDB-AT
15	Y2	To Load OF Y2/C155/EDB-AT
16	Y2	To Load OF Y2/C156/EDB-AT
17	B2	To Load OF B2/C167/EDB-AT
18	B2	To Load OF B2/C168/EDB-AT
19	B2	To Load OF B2/C169/EDB-AT
20	B2	To Load OF B2/C170/EDB-AT
21	B2	To Load OF B2/C171/EDB-AT
22	B2	To Load OF B2/C172/EDB-AT
23	B2	To Load OF B2/C173/EDB-AT
24	Y3	To Load OF Y3/C178/EDB-AT
25	B4	To Load OF B4/C179/EDB-AT
26	B4	To Load OF B4/C180/EDB-AT
R5	R5	DALI
Y5	Y5	DALI
R6	R6	DALI
30	R6	DALI
R1	R1	LINE OF R1/C11/EDB-AT
R1	R1	LINE OF R1/C11/2EDB-AT
Y1	Y1	LINE OF Y1/C123/EDB-AT
Y1	Y1	LINE OF Y1/C123/4EDB-AT
Y1	Y1	LINE OF Y1/C125/EDB-AT
Y1	Y1	LINE OF Y1/C125/EDB-AT
B1	B1	LINE OF B1/C136/EDB-AT
B1	B1	LINE OF B1/C137/EDB-AT
B1	B1	LINE OF B1/C138/EDB-AT
B1	B1	LINE OF B1/C139/EDB-AT
B1	B1	LINE OF B1/C140/EDB-AT
R2	R2	LINE OF R2/C141/EDB-AT
R2	R2	LINE OF R2/C142/EDB-AT
Y2	Y2	LINE OF Y2/C153/EDB-AT
Y2	Y2	LINE OF Y2/C153/4EDB-AT
Y2	Y2	LINE OF Y2/C155/EDB-AT
Y2	Y2	LINE OF Y2/C155/EDB-AT
B2	B2	LINE OF B2/C167/EDB-AT
B2	B2	LINE OF B2/C168/EDB-AT
B2	B2	LINE OF B2/C169/EDB-AT
B2	B2	LINE OF B2/C170/EDB-AT
B2	B2	LINE OF B2/C171/EDB-AT
B2	B2	LINE OF B2/C172/EDB-AT
B2	B2	LINE OF B2/C173/EDB-AT
Y3	Y3	LINE OF Y3/C178/EDB-AT
B4	B4	LINE OF B4/C179/EDB-AT
B4	B4	LINE OF B4/C180/EDB-AT
R6	R6	SPARE
R6	R6	SPARE
R6	R6	TO DALI R12/C11/EDB-AT
N	N	TO DALI R12/C11/EDB-AT
R6	R6	TO POWER SUPPLY CP-D-24.1.3 R1/C11/EDB-AT
N	N	TO POWER SUPPLY CP-D-24.1.3 R1/C11/EDB-AT
N	N	TO POWER SUPPLY CP-D-24.1.3 R1/C11/EDB-AT
E	E	1x10 mm ² Earth wire

DVC-01
SA/S 12.16.6.2/1
ADD: 1.13.5

DVC-02
SA/S 4.16.6.2
ADD: 1.13.6

DVC-04
SA/S 12.16.6.2/2
ADD: 1.13.7

DALI
DVC-04
002.2.64.1.11
ADD: 1.13.7

DVC-01
SA/S 12.16.6.2/1
ADD: 1.13.5

DVC-02
SA/S 4.16.6.2
ADD: 1.13.6

DVC-04
SA/S 12.16.6.2/2
ADD: 1.13.7

DVC-02
002.2.64.1.11
ADD: 1.13.7
DVC-05
0P-2413

GENERAL NOTES:

System Integrator



OWNER:



CONSULTANT:



CONTRACTOR:



PROJECT TITLE:

HSBC Maadi Nile Council

DRAWING TITLE :

KNX PANEL SHOP DRAWINGS

DRAWING NUMBER :

EDB-AT

PAGE: 8/9

PREPARED BY: CHECKED BY: APPROVED BY:

ENG. M.T.	ENG. M.T.	ENG. M.H
DATE	REV.	PROJECT NO. PAPER
Oct-2023	02	-- A4

HSBC 6th floor

		NUMBER OF RETURNS CONTROLLED BY PRESENCE SENSOR ONLY / PIR & LIGHTING SWITCH / LIGHTING SWITCH ONLY	CIRCUIT COLOR	CIRCUIT NO.	RETURNS NO. FOR EACH CIRCUIT	LOCATION	NUMBER OF DALI LIGHTING FIXTURES (DALI DRIVER)	Actuator Address	Actuator Channel	PRESENCE SENSOR	KEYPAD & TOUCH SCREEN
6TH FLOOR	EDB-AT	28	R1	CT1	1	24P HR TRAINING L06-635			A	53	2 KEYPADS
					2	12P HR TRAINING L06-625			B		
			Y1	CT2	3	12P HR TRAINING L06-624			C		
					4	FURNITURE STORAGE L06-615			D		
			B1	CT3	5	PRAYER ROOM L06-612			E		
					6	PRAYER ROOM L06-609			F		
					7	SHOE RACKS L06-610			G		
					8	ABLUTION ROOM L06-611			H		
					9	ABLUTION ROOM L06-613			I		
					10	SHOE RACKS L06-614			J		
			R2	CT4	11	RESTAURANT L06-608			K		
					12	PREP L06-607			L		
			Y2	CT5	13	SHOWER L06-623			A		
					14	SHOWER LOBBY			B		
					15	TOILET LOBBY			C		
					16	Male Toilet L06-620			D		
			B2	CT6	17	KITCHEN WASH AREA L06-616			A		
					18	CIRCULATION L06-606			B		
					19	ELEC ROOM L06-604			C		
					20	STAIRS LOBBY L06-605			D		
21	water tank L06-617	E									
22	KITCHEN STORE L06-603	F									
23	CAFÉ L06-602	G									
Y3	CT8	24	STAIRS L06-653	H							
B4	CT12	25	CIRCULATION L06-647	I							
		26		J							
R6		29	Spare	K							
		30		L							
R5	CT13	27	CAFETERIA L06-601	8	DVC-05						
Y5	CT14	28	CAFETERIA L06-601	11	1.13.8						

GENERAL NOTES:

System Integrator



OWNER:



CONSULTANT :



CONTRACTOR:



PROJECT TITLE:

HSBC Maadi Nile Courch

DRAWING TITLE :

KNX PANEL SHOP DRAWINGS

DRAWING NUMBER :

EDB-AT

PAGE: 9/9

PREPARED BY: CHECKED BY: APPROVED BY:

ENG. M.T	ENG. M.T	ENG. M.H
DATE	REV.	PROJECT NO.
Oct-2023	02	--
		PAPER
		A4